

Summary of Test Results

Reference no. : BC-SUMMARY-2022-065

Customer : Gate Way Valve & Fitting Ltd.

Address : Flat A1, 4/F., Galaxy Factory Building, 25-27 Luk Hop Street, San Po Kong, Kowloon, H. K.

Sample description : Ductile Iron Wafer Type Silent Check Valve

Nominal pressure (PN) : 16

Manufacturer : Cla-Val Pacific Limited

Brand name : Cla-Val

Body marking : CLA-VAL (DN) PN16 DI

Model no. : 580PS-RS

Origin : New Zealand

Sample submitted by : Gate Way Valve & Fitting Ltd.

Test standard : BS EN 12334 : 2001 / WIS 4-52-01 Dec. 1992 : Issue 1 / BS EN 1563 : 2011 / BS EN 10283 : 2010

Test period : 25 April to 24 May 2022

A) Sample List

DN (mm)	Specimen no.
50	220406-2221-001
65	220406-2221-002
80	220406-2221-003
100	220406-2221-004
150	220406-2221-005
200	220406-2221-006

B) Test Item**1) Dimensions Check (BS EN 12334 : 2001 Clause 4.1.3)**

DN (mm)	Test results	Castco LRN
50	Passed	220406-2221
65	Passed	
80	Passed	
100	Passed	
150	Passed	
200	Passed	

2) Coating Thickness Test (WIS 4-52-01 Dec. 1992 : Issue 1 Appendix B)

DN (mm)	Test results	Castco LRN
50	Passed	220406-2221
65	Passed	
80	Passed	
100	Passed	
150	Passed	
200	Passed	

Summary of Test Results

Reference no. : BC-SUMMARY-2022-065

B) Test Item (con't)

3) Pressure Test (BS EN 12334 : 2001 Clause 5.1)

DN (mm)	Test results	Castco LRN
50	Passed	220406-2221
65	Passed	
80	Passed	
100	Passed	
150	Passed	
200	Passed	

4) Tensile Test (BS EN 1563 : 2011 Clause 7.2.1.1 Table 1 (Grade EN-GJS-450-10) and Clause 9.1)

DN (mm)	Test results	Castco LRN
50	Passed	220406-2221
100	Passed	
200	Passed	

5) Chemical Composition (Disc) (BS EN 10283 : 2010 Table 1 Grade 1.4408 (316))

DN (mm)	Test results	Castco LRN
50	Passed	220425-2039
100	Passed	220425-2043
200	Passed	220425-2047

6) Chemical Composition (Seat Ring) (BS EN 10283 : 2010 Table 1 Grade 1.4408 (316))

DN (mm)	Test results	Castco LRN
50	Passed	220425-2040
100	Passed	220425-2044
200	Passed	220425-2048

Prepare by : _____
Date : 07 June 2022

FU HO MAN
Assistant Technical Manager

Review by : _____
Date : 07 June 2022

WONG KA MAN
Senior Manager

Test Report
Check Valves - Dimensions Check
(BS EN 12334 : 2001 Clause 4.1.3)

Date of issue : 24 June 2022

Page 1A of 7 page(s)

Castco LRN : 220406-2221

Details as supplied by customer

Customer : Gate Way Valve & Fitting Ltd.

Customer's ref. no. : - -

Address : Flat A1, 4/F., Galaxy Factory Building, 25-27 Luk Hop Street, San Po Kong, Kowloon, H. K.

Contract no. : - -

Job title : WSD GA of Cla-Val Silent Check Valve Model 580P-RS, 580PS-RS

Sample description : Ductile Iron Wafer Type Silent Check Valve

Nominal pressure (PN) : 16

Manufacturer : Cla-Val Pacific Limited

Brand name : Cla-Val

Body marking : CLA-VAL (DN) PN16 DI

Model no. : 580P-RS / 580PS-RS

Origin : New Zealand

Sample submitted by : Gate Way Valve & Fitting Ltd.

Laboratory test results

Date of sample received : 06 April 2022

Date of test : 25 April 2022

Specimen no.	220406-2221-001	220406-2221-002	220406-2221-003	220406-2221-004	220406-2221-005	220406-2221-006	
DN (mm)	50	65	80	100	150	200	
Ambient temperature (°C)	26.6	26.6	26.6	26.6	26.6	26.6	
A (mm)	Measured mean value	113	138	155	181	253	333
	Manufacturer requirement	108.0	127.0	146.1	177.8	247.7	339.7
B (mm)	Measured mean value	68.35	73.35	80.91	102.33	140.82	165.86
	Manufacturer requirement	66.7	73.0	79.4	101.6	139.7	165.1
C (mm)	Measured mean value	61.47	69.86	84.44	112.49	161.25	210.49
	Manufacturer requirement	60.3	73.0	85.7	120.7	165.1	215.9

Remark(s) :

1. Test results relate only to the specimen tested.
2. Test samples are compatible with BS EN 1092-2 flange connections.
3. This page no. 1A of this test report supersedes page no. 1 of the previous test report of Castco LRN : 220406-2221 issued on 07 June 2022 with amendment : "Remark 2" was added due to customer request.

Checked by : **FU HO MAN**
Assistant Technical Manager

Certified by : **WONG KA MAN**
Senior Manager

香港粉嶺安居街33號
香港粉嶺安全街29A號
E-mail: info@castco.com.hk33, On Kui Street, Fanling, Hong Kong. Tel : 2597 8333
29A, On Chuen Street, Fanling, Hong Kong. Fax: 2597 8399
Website: www.castco.com.hk

Test Report

Valves - Coating Thickness Measurement

(WIS 4-52-01 Dec. 1992 : Issue 1 Appendix B in conjunction with the following specification(s) : WIS 4-52-01 Dec. 1992 : Issue 1 Cl. 12.7.1)

Date of issue : 07 June 2022

Page 2 of 7 page(s)

Castco LRN : 220406-2221

Details as supplied by customer

Customer : Gate Way Valve & Fitting Ltd.

Customer's ref. no. : - -

Address : Flat A1, 4/F., Galaxy Factory Building, 25-27 Luk Hop Street, San Po Kong, Kowloon, H. K.

Contract no. : - -

Job title : WSD GA of Cla-Val Silent Check Valve Model 580P-RS, 580PS-RS

Sample description : Ductile Iron Wafer Type Silent Check Valve

Nominal pressure (PN) : 16

Manufacturer : Cla-Val Pacific Limited

Brand name : Cla-Val

Body marking : CLA-VAL (DN) PN16 DI

Model no. : 580P-RS / 580PS-RS

Origin : New Zealand

Sample submitted by : Gate Way Valve & Fitting Ltd.

Laboratory test results

Date of sample received : 06 April 2022

Date of test : 25 April 2022

Specimen no.	220406-2221-001	220406-2221-002	220406-2221-003	220406-2221-004	220406-2221-005	220406-2221-006
DN (mm)	50	65	80	100	150	200
Ambient temperature (°C)	26.6	26.6	26.6	26.6	26.6	26.6
Measured value of coating thickness at external surface (µm)	1	707	155	626	582	518
	2	712	276	638	588	512
	3	854	153	616	533	415
	4	867	180	679	521	535
	5	744	250	699	522	468
Measured value of coating thickness at internal surface (µm)	6	782	348	497	570	331
	7	795	381	460	546	481
	8	768	373	480	581	591
	9	704	421	474	537	569
	10	346	314	501	533	614
	11	328	347	461	540	601
	12	518	267	496	537	577
	13	540	262	558	520	428
	14	775	380	631	470	582
	15	624	396	657	443	467
Mean	670.9	300.2	564.9	534.9	512.6	581.0
Minimum coating thickness (µm)	328	153	460	443	331	481
Maximum coating thickness (µm)	867	421	699	588	614	666
Standard deviation (µm)	168.0	88.4	87.1	39.5	80.9	54.8
Manufacturer requirement (µm)	Minimum coating thickness	min. 100				
	Maximum coating thickness	max. 1500				

Remark(s) :

1. Test results relate only to the specimen tested.

Checked by : _____

FU HO MAN
Assistant Technical Manager

Approved Signatory : _____

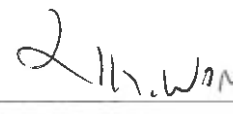
WONG KA MAN
Senior Manager



香港粉嶺安居街33號
香港粉嶺安全街29A號
E-mail: info@castco.com.hk

33, On Kui Street, Fanling, Hong Kong. Tel : 2597 8333
29A, On Chuen Street, Fanling, Hong Kong. Fax: 2597 8399
Website: www.castco.com.hk

Test Report
Metallic Valves - Shell and Seat Tightness
(BS EN 12266-1 : 2012 Annex A3 and A4)

Date of issue : 07 June 2022

Page 3 of 7 page(s)

Castco LRN : 220406-2221

Details as supplied by customer

Customer : Gate Way Valve & Fitting Ltd.

Customer's ref. no. : - -

Address : Flat A1, 4/F., Galaxy Factory Building, 25-27 Luk Hop Street, San Po Kong, Kowloon, H. K. Contract no. : - -

Job title : WSD GA of Cla-Val Silent Check Valve Model 580P-RS, 580PS-RS

Sample description : Ductile Iron Wafer Type Silent Check Valve

Nominal pressure (PN) : 16

Manufacturer : Cla-Val Pacific Limited

Brand name : Cla-Val

Body marking : CLA-VAL (DN) PN16 DI

Model no. : 580P-RS / 580PS-RS

Origin : New Zealand

Sample submitted by : Gate Way Valve & Fitting Ltd.

Laboratory test results

Date of sample received : 06 April 2022

Date of test : 25 April 2022

A) Shell Tightness

Specimen no.	220406-2221-001	220406-2221-002	220406-2221-003	220406-2221-004	220406-2221-005	220406-2221-006
DN (mm)	50	65	80	100	150	200
Ambient temperature (°C)	26.6	26.6	26.6	26.6	26.6	26.6
Water temperature (°C)	21.5	21.5	21.5	21.5	21.5	21.5
Apply pressure (bar)	24	24	24	24	24	24
Test duration (s)	60	60	60	60	60	120
Visually detectable leakage	No	No	No	No	No	No
Requirement	Visually detectable leakage is not permitted					

Test Report
Metallic Valves - Shell and Seat Tightness
(BS EN 12266-1 : 2012 Annex A3 and A4)

Date of issue : 07 June 2022

Page 4 of 7 page(s)

Castco LRN : 220406-2221

Laboratory test results (con't)

B) Seat Tightness

Specimen no.	220406-2221-001	220406-2221-002	220406-2221-003	220406-2221-004	220406-2221-005	220406-2221-006
DN (mm)	50	65	80	100	150	200
Water temperature (°C)	21.5	21.5	21.5	21.5	21.5	21.5
Apply pressure (bar)	17.6	17.6	17.6	17.6	17.6	17.6
Test duration (s)	60	60	60	60	60	120
Leakage rate (mm ³ /s)	0	0	0	0	0	0
Requirement	The leakage rate shall not exceed specified in BS EN 12266-1 : 2012 Annex A.4.3 Table A.5					

Remark(s) :

1. Test results relate only to the specimen tested.
2. Test results of sample comply with the requirement of BS EN 12334 : 2001 Clause 5.1 (this specification is not covered by the laboratory's HOKLAS accreditation).

Checked by :

FU HO MAN
 Assistant Technical Manager

Approved Signatory :

WONG KA MAN
 Senior Manager

香港粉嶺安居街33號
香港粉嶺安全街29A號
E-mail: info@castco.com.hk

33, On Kui Street, Fanling, Hong Kong. Tel : 2597 8333
29A, On Chuen Street, Fanling, Hong Kong. Fax: 2597 8399
Website: www.castco.com.hk

Test Report
Metallic Materials - Tensile Test of Metallic Materials
(BS EN ISO 6892-1 : 2009)

Date of issue : 07 June 2022

Page 5 of 7 page(s)

Castco LRN : 220406-2221

Details as supplied by customer

Customer : Gate Way Valve & Fitting Ltd. Customer's ref. no. : --
Address : Flat A1, 4/F., Galaxy Factory Building, 25-27 Luk Hop Street, San Po Kong, Kowloon, H. K. Contract no. : --
Job title : WSD GA of Cla-Val Silent Check Valve Model 580P-RS, 580PS-RS
Sample description : Ductile Iron Wafer Type Silent Check Valve
Nominal pressure (PN) : 16
Manufacturer : Cla-Val Pacific Limited
Brand name : Cla-Val
Body marking : CLA-VAL (DN) PN16 DI
Model no. : 580P-RS / 580PS-RS
Origin : New Zealand
Sample submitted by : Gate Way Valve & Fitting Ltd.
Acceptance standard : BS EN 1563 : 2011 Clause 7.2.1.1 Table 1 (Grade EN-GJS-450-10) and Clause 9.1

Laboratory test results

Date of sample received : 06 April 2022

Date of test : 27 April 2022

Tensile Test

Specimen no.	DN (mm)	Type & Prepar'n	Specimen length (mm)	Area (mm ²)	Yield strength (MPa)	Tensile strength (MPa)	Elongation (%)	Position of fracture	Remark
220406-2221-001	50	B, M	149	157.0	312	476	16.3	Valid	--
220406-2221-004	100	B, M	149	157.5	320	485	15.3	Valid	--
220406-2221-006	200	B, M	149	156.8	317	476	16.9	Valid	--

Remark(s) :

- A - Proportional; B - Non - proportional; M - Machined; N - Unmachined;
+ - This measurement is 'invalid' which relates to the position of fracture only.
- The yield strength is determined at 0.2% proof strength.
- Test results relate only to the specimen tested.
- Test results of sample comply with the requirement of BS EN 1563 : 2011 Table 1 (this specification is not covered by the laboratory's HOKLAS accreditation).
- The requirement of BS EN 1563 : 2011 Table 1 : 0.2% proof strength = min. 310MPa; Tensile strength = min. 450MPa; Elongation = min. 10%.
- The acceptance limit is the same as the tolerance limit (simple acceptance, see Figure A). Only test results out of the tolerance/acceptance limit will be concluded as out-of-tolerance.



Figure A - Graphical representation of a binary statement - Simple acceptance

Checked by :

FU HO MAN
Assistant Technical Manager

Approved Signatory :

WONG KA MAN
Senior Manager

Form no. : ST 6892_T1(for BC)_dd_02/01/2020

Test Report

Check Valves - Dimensions Check
(BS EN 12334 : 2001 Clause 4.1.3)

Date of issue : 07 June 2022

Page 6 of 7 page(s)

Castco LRN : 220406-2221

Appendix A220406-2221-001220406-2221-002220406-2221-003220406-2221-004220406-2221-005220406-2221-006

Test Report
Check Valves - Dimensions Check
(BS EN 12334 : 2001 Clause 4.1.3)

Date of issue : 07 June 2022

Page 7 of 7 page(s)

Castco LRN : 220406-2221

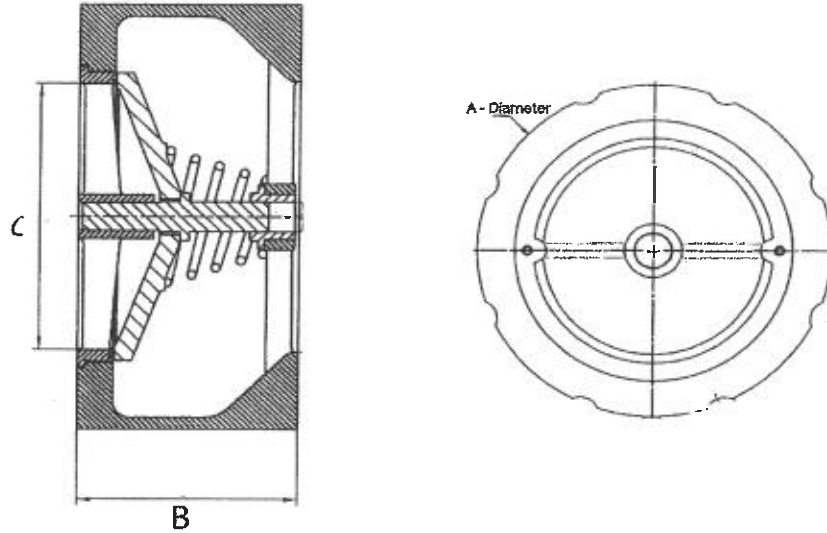
Appendix BDimensions Figure (220406-2221)

End of Report

Form no. : BC_CHECK VALVE_DIM_BSEN12334-2001_T_dd_07/12/2021

香港粉嶺安居街33號得利中心6樓 • 6/F, Techno Centre, 33, On Kui Street, Fanling, Hong Kong.
香港粉嶺安居街30號新寧中心1樓 • 1/F, Sun Ling Plaza, 30, On Kui Street, Fanling, Hong Kong.
香港粉嶺安全街29A號 • 29A, On Chuen Street, Fanling, Hong Kong.
Tel: 2597 8333 Fax: 2597 8399 E-mail: info@castco.com.hk Website: www.castco.com.hk

**Test Report
Chemical Analysis of Steel**

Date of issue: 08-07-2022

Specimen No.: CHEM-220425-2039-001

Page 1A of 2

Castco LRN: 220425-2039

Details as supplied by customer

Name of Customer : Gate Way Valve & Fitting Limited
Address : Flat A1, 4/F, Galaxy Fty Bldg, 25-27 Luk Hop Street, San Po Kong, Kowloon, Hong Kong
Job Title : WSD GA of Cla-Val Silent Check Valve Model 580P-RS, 580PS-RS
Contract No. : --
Customer's Ref. No. : --

Sample details as supplied by customer

Date Sampled : --
Sample Description : DN50 Ductile Iron Wafer Type Silent Check Valve (Disc)
Specification : BS EN 10283:2010, Table 1, Grade 1.4408 (316)
Specimen No. : 220406-2221-001
Sample Identification No. : -- / Model no. : 580PS-RS / Origin : New Zealand
Location of Works : --
Manufacturer : Cla-Val Pacific Limited / Brand name: Cla-Val

Test Method(s):-

- 1) BS EN ISO 15350 : 2010
- 2) ST-Multi-1(ICP-OES)
- 3) BS EN ISO 15351: 2010

Remark(s):

- I. Test results only relate to the specimen tested.
- II. This page no. 1A of this test report supersedes page no. 1 of the previous test report of Castco LRN 220425-2039 issued on 30-05-2022.
- III. The test results of Nitrogen content was removed in this report due to this parameter is not required by the specification.

Checked by :

Lau Hiu Yat
Assistant Technical Manager

Approved Signatory :

Cheng Chi Fai
Senior Manager

Test Report

Chemical Analysis of Steel

Date of issue: 08-07-2022
Page 2A of 2Specimen No.: CHEM-220425-2039-001
Castco LRN: 220425-2039**Laboratory test details**

Date of Request Confirmed: 25-04-2022

Date of Received by Lab.: 25-04-2022

Testing Period: 06-05-2022 to 24-05-2022

Chemical Analysis		Result
¹⁾ Total Carbon Content	C %	0.030
¹⁾ Total Sulfur Content	S %	0.0041
²⁾ Chromium	Cr %	18.41
²⁾ Manganese	Mn %	1.13
²⁾ Molybdenum	Mo %	2.22
²⁾ Nickel	Ni %	10.02
²⁾ Phosphorus	P %	0.026
²⁾ Silicon	Si %	0.796

Remark(s):

- I. This page no. 2A of this test report supersedes page no. 2 of the previous test report of Castco LRN 220425-2039 issued on 30-05-2022.
- II. The test results of Nitrogen content was removed in this report due to this parameter is not required by the specification.

End of Report

Form No.: CHM Steel-1 T dd 16/12/2015

Appendix A

Summary of Chemical Analysis of Steel

Date of issue: 08-07-2022

Specimen No.: CHEM-220425-2039-001

Page 1 of 1

Castco LRN: 220425-2039

Name of Customer: Gate Way Valve & Fitting Limited

Job Title: WSD GA of Cla-Val Silent Check Valve Model 580P-RS, 580PS-RS

Contract No.: --

Customer's Ref. No.: --

Date of Received by Lab.: 25-04-2022

Testing Period: 06-05-2022 to 24-05-2022

Castco LRN:	220425-2039				
Sample Description :	DN50 Ductile Iron Wafer Type Silent Check Valve (Disc)				
Specimen No. :	220406-2221-001				
Sample Identification No.:	-- / Model no. : 580PS-RS / Origin : New Zealand				
Manufacturer :	Cla-Val Pacific Limited / Brand name: Cla-Val				
Specification: BS EN 10283:2010, Table 1, Grade 1.4408 (316)			Test Results	Within / Exceed limit	
Carbon	C	0.07 max.	%	0.030	Within limit
Sulfur	S	0.030 max.	%	0.0041	Within limit
Chromium	Cr	18.00 to 20.00	%	18.41	Within limit
Manganese	Mn	1.50 max.	%	1.13	Within limit
Molybdenum	Mo	2.00 to 2.50	%	2.22	Within limit
Nickel	Ni	9.00 to 12.00	%	10.02	Within limit
Phosphorus	P	0.040 max.	%	0.026	Within limit
Silicon	Si	1.50 max.	%	0.796	Within limit

Remark(s):

- I. Test results only relate to the specimen tested.
- II. Test results of the specimen are in compliance with the chemical requirements of BS EN 10283:2010, Table 1, Grade 1.4408 (316).

**Test Report
Chemical Analysis of Steel**Date of issue: 08-07-2022
Page 1A of 2Specimen No.: CHEM-220425-2040-001
Castco LRN: 220425-2040**Details as supplied by customer**

Name of Customer : Gate Way Valve & Fitting Limited
Address : Flat A1, 4/F, Galaxy Fty Bldg, 25-27 Luk Hop Street, San Po Kong, Kowloon, Hong Kong
Job Title : WSD GA of Cla-Val Silent Check Valve Model 580P-RS, 580PS-RS
Contract No. : --
Customer's Ref. No. : --

Sample details as supplied by customer

Date Sampled : --
Sample Description : DN50 Ductile Iron Wafer Type Silent Check Valve (Seat Ring)
Specification : BS EN 10283:2010, Table 1, Grade 1.4408 (316)
Specimen No. : 220406-2221-001
Sample Identification No. : -- / Model no. : 580PS-RS / Origin : New Zealand
Location of Works : --
Manufacturer : Cla-Val Pacific Limited / Brand name: Cla-Val

Test Method(s):-

- 1) BS EN ISO 15350 : 2010
- 2) ST-Multi-1(ICP-OES)
- 3) BS EN ISO 15351: 2010

Remark(s):

- I. Test results only relate to the specimen tested.
- II. This page no. 1A of this test report supersedes page no. 1 of the previous test report of Castco LRN 220425-2040 issued on 30-05-2022.
- III. The test results of Nitrogen content was removed in this report due to this parameter is not required by the specification.

Checked by : 
Lau Hiu Yat
Assistant Technical ManagerApproved Signatory : 
Cheng Chi Fai
Senior Manager

Test Report

Chemical Analysis of Steel

Date of issue: 08-07-2022
Page 2A of 2Specimen No.: CHEM-220425-2040-001
Castco LRN: 220425-2040**Laboratory test details**

Date of Request Confirmed: 25-04-2022 Date of Received by Lab.: 25-04-2022
Testing Period: 06-05-2022 to 24-05-2022

Chemical Analysis	Result
1 ⁾ Total Carbon Content C %	0.030
1 ⁾ Total Sulfur Content S %	0.0043
2 ⁾ Chromium Cr %	18.28
2 ⁾ Manganese Mn %	1.14
2 ⁾ Molybdenum Mo %	2.21
2 ⁾ Nickel Ni %	10.01
2 ⁾ Phosphorus P %	0.027
2 ⁾ Silicon Si %	0.791

Remark(s):

- I. This page no. 2A of this test report supersedes page no. 2 of the previous test report of Castco LRN 220425-2040 issued on 30-05-2022.
- II. The test results of Nitrogen content was removed in this report due to this parameter is not required by the specification.

End of Report

Form No.: CHM Steel-1 T dd 16/12/2015

Appendix A

Summary of Chemical Analysis of Steel

Date of issue: 08-07-2022

Specimen No.: CHEM-220425-2040-001

Page 1 of 1

Castco LRN: 220425-2040

Name of Customer: Gate Way Valve & Fitting Limited

Job Title: WSD GA of Cla-Val Silent Check Valve Model 580P-RS, 580PS-RS

Contract No.: --

Customer's Ref. No.: --

Date of Received by Lab.: 25-04-2022

Testing Period: 06-05-2022 to 24-05-2022

Castco LRN:	220425-2040				
Sample Description :	DN50 Ductile Iron Wafer Type Silent Check Valve (Seat Ring)				
Specimen No. :	220406-2221-001				
Sample Identification No.:	-- / Model no. : 580PS-RS / Origin : New Zealand				
Manufacturer :	Cla-Val Pacific Limited / Brand name: Cla-Val				
Specification: BS EN 10283:2010, Table 1, Grade 1.4408 (316)			Test Results	Within / Exceed limit	
Carbon	C	0.07 max.	%	0.030	Within limit
Sulfur	S	0.030 max.	%	0.0043	Within limit
Chromium	Cr	18.00 to 20.00	%	18.28	Within limit
Manganese	Mn	1.50 max.	%	1.14	Within limit
Molybdenum	Mo	2.00 to 2.50	%	2.21	Within limit
Nickel	Ni	9.00 to 12.00	%	10.01	Within limit
Phosphorus	P	0.040 max.	%	0.027	Within limit
Silicon	Si	1.50 max.	%	0.791	Within limit

Remark(s):

- I. Test results only relate to the specimen tested.
- II. Test results of the specimen are in compliance with the chemical requirements of BS EN 10283:2010, Table 1, Grade 1.4408 (316).

Test Report**Chemical Analysis of Steel**

Date of issue: 08-07-2022

Specimen No.: CHEM-220425-2043-001

Page 1A of 2

Castco LRN: 220425-2043

Details as supplied by customer

Name of Customer : Gate Way Valve & Fitting Limited

Address : Flat A1, 4/F, Galaxy Fty Bldg, 25-27 Luk Hop Street, San Po Kong, Kowloon, Hong Kong

Job Title : WSD GA of Cla-Val Silent Check Valve Model 580P-RS, 580PS-RS

Contract No. : --

Customer's Ref. No. : --

Sample details as supplied by customer

Date Sampled : --

Sample Description : DN100 Ductile Iron Wafer Type Silent Check Valve (Disc)

Specification : BS EN 10283:2010, Table 1, Grade 1.4408 (316)

Specimen No. : 220406-2221-004

Sample Identification No. : -- / Model no. : 580PS-RS / Origin : New Zealand

Location of Works : --

Manufacturer : Cla-Val Pacific Limited / Brand name: Cla-Val

Test Method(s):-

- 1) BS EN ISO 15350 : 2010
- 2) ST-Multi-1(ICP-OES)
- 3) BS EN ISO 15351: 2010

Remark(s):

- I. Test results only relate to the specimen tested.
- II. This page no. 1A of this test report supersedes page no. 1 of the previous test report of Castco LRN 220425-2043 issued on 30-05-2022.
- III. The test results of Nitrogen content was removed in this report due to this parameter is not required by the specification.

Checked by :

Lau Hiu Yat

Assistant Technical Manager

Approved Signatory :

Cheng Chi Fai

Senior Manager

**Test Report
Chemical Analysis of Steel**Date of issue: 08-07-2022
Page 2A of 2Specimen No.: CHEM-220425-2043-001
Castco LRN: 220425-2043**Laboratory test details**

Date of Request Confirmed: 25-04-2022

Date of Received by Lab.: 25-04-2022

Testing Period: 06-05-2022 to 24-05-2022

Chemical Analysis		Result
¹⁾ Total Carbon Content	C %	0.030
¹⁾ Total Sulfur Content	S %	0.0045
²⁾ Chromium	Cr %	18.31
²⁾ Manganese	Mn %	1.14
²⁾ Molybdenum	Mo %	2.21
²⁾ Nickel	Ni %	10.03
²⁾ Phosphorus	P %	0.026
²⁾ Silicon	Si %	0.789

Remark(s):

- I. This page no. 2A of this test report supersedes page no. 2 of the previous test report of Castco LRN 220425-2043 issued on 30-05-2022.
- II. The test results of Nitrogen content was removed in this report due to this parameter is not required by the specification.

End of Report

Form No.: CHM Steel-1 T dd 16/12/2015

Appendix A

Summary of Chemical Analysis of Steel

Date of issue: 08-07-2022

Specimen No.: CHEM-220425-2043-001

Page 1 of 1

Castco LRN: 220425-2043

Name of Customer: Gate Way Valve & Fitting Limited

Job Title: WSD GA of Cla-Val Silent Check Valve Model 580P-RS, 580PS-RS

Contract No.: --

Customer's Ref. No.: --

Date of Received by Lab.: 25-04-2022

Testing Period: 06-05-2022 to 24-05-2022

Castco LRN:	220425-2043				
Sample Description :	DN100 Ductile Iron Wafer Type Silent Check Valve (Disc)				
Specimen No. :	220406-2221-004				
Sample Identification No.:	-- / Model no. : 580PS-RS / Origin : New Zealand				
Manufacturer :	Cla-Val Pacific Limited / Brand name: Cla-Val				
Specification: BS EN 10283:2010, Table 1, Grade 1.4408 (316)			Test Results	Within / Exceed limit	
Carbon	C	0.07 max.	%	0.030	Within limit
Sulfur	S	0.030 max.	%	0.0045	Within limit
Chromium	Cr	18.00 to 20.00	%	18.31	Within limit
Manganese	Mn	1.50 max.	%	1.14	Within limit
Molybdenum	Mo	2.00 to 2.50	%	2.21	Within limit
Nickel	Ni	9.00 to 12.00	%	10.03	Within limit
Phosphorus	P	0.040 max.	%	0.026	Within limit
Silicon	Si	1.50 max.	%	0.789	Within limit

Remark(s):

- I. Test results only relate to the specimen tested.
- II. Test results of the specimen are in compliance with the chemical requirements of BS EN 10283:2010, Table 1, Grade 1.4408 (316).

Test Report**Chemical Analysis of Steel**

Date of issue: 08-07-2022

Specimen No.: CHEM-220425-2044-001

Page 1A of 2

Castco LRN: 220425-2044

Details as supplied by customer

Name of Customer : Gate Way Valve & Fitting Limited

Address : Flat A1, 4/F, Galaxy Fty Bldg, 25-27 Luk Hop Street, San Po Kong, Kowloon, Hong Kong

Job Title : WSD GA of Cla-Val Silent Check Valve Model 580P-RS, 580PS-RS

Contract No. : --

Customer's Ref. No. : --

Sample details as supplied by customer

Date Sampled : --

Sample Description : DN100 Ductile Iron Wafer Type Silent Check Valve (Seat Ring)

Specification : BS EN 10283:2010, Table 1, Grade 1.4408 (316)

Specimen No. : 220406-2221-004

Sample Identification No. : -- / Model no. : 580PS-RS / Origin : New Zealand

Location of Works : --

Manufacturer : Cla-Val Pacific Limited / Brand name: Cla-Val

Test Method(s):-

- 1) BS EN ISO 15350 : 2010
- 2) ST-Multi-1(ICP-OES)
- 3) BS EN ISO 15351: 2010

Remark(s):

- I. Test results only relate to the specimen tested.
- II. This page no. 1A of this test report supersedes page no. 1 of the previous test report of Castco LRN 220425-2044 issued on 30-05-2022.
- III. The test results of Nitrogen content was removed in this report due to this parameter is not required by the specification.

Checked by : Lau Hiu Yat
Assistant Technical ManagerApproved Signatory : Cheng Chi Fai
Senior Manager

**Test Report
Chemical Analysis of Steel**Date of issue: 08-07-2022
Page 2A of 2Specimen No.: CHEM-220425-2044-001
Castco LRN: 220425-2044**Laboratory test details**Date of Request Confirmed: 25-04-2022 Date of Received by Lab.: 25-04-2022
Testing Period: 06-05-2022 to 24-05-2022

Chemical Analysis		Result
¹⁾ Total Carbon Content	C %	0.029
¹⁾ Total Sulfur Content	S %	0.0052
²⁾ Chromium	Cr %	18.26
²⁾ Manganese	Mn %	1.17
²⁾ Molybdenum	Mo %	2.28
²⁾ Nickel	Ni %	10.52
²⁾ Phosphorus	P %	0.025
²⁾ Silicon	Si %	0.884

Remark(s):

- I. This page no. 2A of this test report supersedes page no. 2 of the previous test report of Castco LRN 220425-2044 issued on 30-05-2022.
- II. The test results of Nitrogen content was removed in this report due to this parameter is not required by the specification.

End of Report

Form No.: CHM Steel-1 T dd 16/12/2015

Appendix A

Summary of Chemical Analysis of Steel

Date of issue: 08-07-2022

Specimen No.: CHEM-220425-2044-001

Page 1 of 1

Castco LRN: 220425-2044

Name of Customer: Gate Way Valve & Fitting Limited

Job Title: WSD GA of Cla-Val Silent Check Valve Model 580P-RS, 580PS-RS

Contract No.: --

Customer's Ref. No.: --

Date of Received by Lab.: 25-04-2022

Testing Period: 06-05-2022 to 24-05-2022

Castco LRN:	220425-2044				
Sample Description :	DN100 Ductile Iron Wafer Type Silent Check Valve (Seat Ring)				
Specimen No. :	220406-2221-004				
Sample Identification No.:	-- / Model no. : 580PS-RS / Origin : New Zealand				
Manufacturer :	Cla-Val Pacific Limited / Brand name: Cla-Val				
Specification: BS EN 10283:2010, Table 1, Grade 1.4408 (316)			Test Results	Within / Exceed limit	
Carbon	C	0.07 max.	%	0.029	Within limit
Sulfur	S	0.030 max.	%	0.0052	Within limit
Chromium	Cr	18.00 to 20.00	%	18.26	Within limit
Manganese	Mn	1.50 max.	%	1.17	Within limit
Molybdenum	Mo	2.00 to 2.50	%	2.28	Within limit
Nickel	Ni	9.00 to 12.00	%	10.52	Within limit
Phosphorus	P	0.040 max.	%	0.025	Within limit
Silicon	Si	1.50 max.	%	0.884	Within limit

Remark(s):

- I. Test results only relate to the specimen tested.
- II. Test results of the specimen are in compliance with the chemical requirements of BS EN 10283:2010, Table 1, Grade 1.4408 (316).

**Test Report
Chemical Analysis of Steel**

Date of issue: 08-07-2022

Specimen No.: CHEM-220425-2047-001

Page 1A of 2

Castco LRN: 220425-2047

Details as supplied by customer

Name of Customer : Gate Way Valve & Fitting Limited
Address : Flat A1, 4/F, Galaxy Fty Bldg, 25-27 Luk Hop Street, San Po Kong, Kowloon, Hong Kong
Job Title : WSD GA of Cla-Val Silent Check Valve Model 580P-RS, 580PS-RS
Contract No. : --
Customer's Ref. No. : --

Sample details as supplied by customer

Date Sampled : --
Sample Description : DN200 Ductile Iron Wafer Type Silent Check Valve (Disc)
Specification : BS EN 10283:2010, Table 1, Grade 1.4408 (316)
Specimen No. : 220406-2221-006
Sample Identification No. : -- / Model no. : 580PS-RS / Origin : New Zealand
Location of Works : --
Manufacturer : Cla-Val Pacific Limited / Brand name: Cla-Val

Test Method(s):-

- 1) BS EN ISO 15350 : 2010
- 2) ST-Multi-1(ICP-OES)
- 3) BS EN ISO 15351: 2010

Remark(s):

- I. Test results only relate to the specimen tested.
- II. This page no. 1A of this test report supersedes page no. 1 of the previous test report of Castco LRN 220425-2047 issued on 30-05-2022.
- III. The test results of Nitrogen content was removed in this report due to this parameter is not required by the specification.

Checked by : _____

Lau Hiu Yat
Assistant Technical Manager

Approved Signatory : _____

Cheng Chi Fai
Senior Manager

Test Report

Chemical Analysis of Steel

Date of issue: 08-07-2022
Page 2A of 2Specimen No.: CHEM-220425-2047-001
Castco LRN: 220425-2047**Laboratory test details**

Date of Request Confirmed: 25-04-2022 Date of Received by Lab.: 25-04-2022
Testing Period: 06-05-2022 to 24-05-2022

Chemical Analysis	Result
1) Total Carbon Content C %	0.029
1) Total Sulfur Content S %	0.0047
2) Chromium Cr %	18.47
2) Manganese Mn %	1.10
2) Molybdenum Mo %	2.17
2) Nickel Ni %	10.06
2) Phosphorus P %	0.027
2) Silicon Si %	0.832

Remark(s):

- I. This page no. 2A of this test report supersedes page no. 2 of the previous test report of Castco LRN 220425-2047 issued on 30-05-2022.
- II. The test results of Nitrogen content was removed in this report due to this parameter is not required by the specification.

End of Report

Form No.: CHM Steel-1 T dd 16/12/2015

Appendix A**Summary of Chemical Analysis of Steel**

Date of issue: 08-07-2022

Specimen No.: CHEM-220425-2047-001

Page 1 of 1

Castco LRN: 220425-2047

Name of Customer: Gate Way Valve & Fitting Limited
 Job Title: WSD GA of Cla-Val Silent Check Valve Model 580P-RS, 580PS-RS
 Contract No.: --
 Customer's Ref. No.: --
 Date of Received by Lab.: 25-04-2022 Testing Period: 06-05-2022 to 24-05-2022

Castco LRN:	220425-2047				
Sample Description :	DN200 Ductile Iron Wafer Type Silent Check Valve (Disc)				
Specimen No. :	220406-2221-006				
Sample Identification No.:	-- / Model no. : 580PS-RS / Origin : New Zealand				
Manufacturer :	Cla-Val Pacific Limited / Brand name: Cla-Val				
Specification: BS EN 10283:2010, Table 1, Grade 1.4408 (316)			Test Results	Within / Exceed limit	
Carbon	C	0.07 max.	%	0.029	Within limit
Sulfur	S	0.030 max.	%	0.0047	Within limit
Chromium	Cr	18.00 to 20.00	%	18.47	Within limit
Manganese	Mn	1.50 max.	%	1.10	Within limit
Molybdenum	Mo	2.00 to 2.50	%	2.17	Within limit
Nickel	Ni	9.00 to 12.00	%	10.06	Within limit
Phosphorus	P	0.040 max.	%	0.027	Within limit
Silicon	Si	1.50 max.	%	0.832	Within limit

Remark(s):

- I. Test results only relate to the specimen tested.
- II. Test results of the specimen are in compliance with the chemical requirements of BS EN 10283:2010, Table 1, Grade 1.4408 (316).

**Test Report
Chemical Analysis of Steel**

Date of issue: 08-07-2022

Specimen No.: CHEM-220425-2048-001

Page 1A of 2

Castco LRN: 220425-2048

Details as supplied by customer

Name of Customer : Gate Way Valve & Fitting Limited
Address : Flat A1, 4/F, Galaxy Fty Bldg, 25-27 Luk Hop Street, San Po Kong, Kowloon, Hong Kong
Job Title : WSD GA of Cla-Val Silent Check Valve Model 580P-RS, 580PS-RS
Contract No. : --
Customer's Ref. No. : --

Sample details as supplied by customer

Date Sampled : --
Sample Description : DN200 Ductile Iron Wafer Type Silent Check Valve (Seat Ring)
Specification : BS EN 10283:2010, Table 1, Grade 1.4408 (316)
Specimen No. : 220406-2221-006
Sample Identification No. : -- / Model no. : 580PS-RS / Origin : New Zealand
Location of Works : --
Manufacturer : Cla-Val Pacific Limited / Brand name: Cla-Val

Test Method(s):-

- 1) BS EN ISO 15350 : 2010
- 2) ST-Multi-1(ICP-OES)
- 3) BS EN ISO 15351: 2010

Remark(s):

- I. Test results only relate to the specimen tested.
- II. This page no. 1A of this test report supersedes page no. 1 of the previous test report of Castco LRN 220425-2048 issued on 30-05-2022.
- III. The test results of Nitrogen content was removed in this report due to this parameter is not required by the specification.

Checked by : _____

Lau Hin Yat
Assistant Technical Manager

Approved Signatory : _____

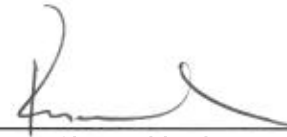
Cheng Chi Fai
Senior Manager

Test Report**Chemical Analysis of Steel**Date of issue: 08-07-2022
Page 2A of 2Specimen No.: CHEM-220425-2048-001
Castco LRN: 220425-2048**Laboratory test details**Date of Request Confirmed: 25-04-2022 Date of Received by Lab.: 25-04-2022
Testing Period: 06-05-2022 to 24-05-2022

Chemical Analysis		Result
¹⁾ Total Carbon Content	C %	0.030
¹⁾ Total Sulfur Content	S %	0.0048
²⁾ Chromium	Cr %	18.17
²⁾ Manganese	Mn %	1.09
²⁾ Molybdenum	Mo %	2.17
²⁾ Nickel	Ni %	10.05
²⁾ Phosphorus	P %	0.026
²⁾ Silicon	Si %	0.808

Remark(s):

- I. This page no. 2A of this test report supersedes page no. 2 of the previous test report of Castco LRN 220425-2048 issued on 30-05-2022.
- II. The test results of Nitrogen content was removed in this report due to this parameter is not required by the specification.

End of Report

Form No.: CHM Steel-1 T dd 16/12/2015

Appendix A

Summary of Chemical Analysis of Steel

Date of issue: 08-07-2022

Specimen No.: CHEM-220425-2048-001

Page 1 of 1

Castco LRN: 220425-2048

Name of Customer: Gate Way Valve & Fitting Limited
 Job Title: WSD GA of Cla-Val Silent Check Valve Model 580P-RS, 580PS-RS
 Contract No.: --
 Customer's Ref. No.: --
 Date of Received by Lab.: 25-04-2022 Testing Period: 06-05-2022 to 24-05-2022

Castco LRN:	220425-2048				
Sample Description :	DN200 Ductile Iron Wafer Type Silent Check Valve (Seat Ring)				
Specimen No. :	220406-2221-006				
Sample Identification No.:	-- / Model no. : 580PS-RS / Origin : New Zealand				
Manufacturer :	Cla-Val Pacific Limited / Brand name: Cla-Val				
Specification: BS EN 10283:2010, Table 1, Grade 1.4408 (316)			Test Results	Within / Exceed limit	
Carbon	C	0.07 max.	%	0.030	Within limit
Sulfur	S	0.030 max.	%	0.0048	Within limit
Chromium	Cr	18.00 to 20.00	%	18.17	Within limit
Manganese	Mn	1.50 max.	%	1.09	Within limit
Molybdenum	Mo	2.00 to 2.50	%	2.17	Within limit
Nickel	Ni	9.00 to 12.00	%	10.05	Within limit
Phosphorus	P	0.040 max.	%	0.026	Within limit
Silicon	Si	1.50 max.	%	0.808	Within limit

Remark(s):

- I. Test results only relate to the specimen tested.
- II. Test results of the specimen are in compliance with the chemical requirements of BS EN 10283:2010, Table 1, Grade 1.4408 (316).