

Summary of Test Results

Reference no. : BC-SUMMARY-2020-52

Customer : Gate Way Valve & Fitting Ltd.

Address : Flat A1, 4/F Galaxy Factory Building, 25 Luk Hop Street, San Po Kong, Kowloon

Sample description : Wafer Check Valve

Nominal pressure (PN) : 16

Manufacturer : Waterfront Fluid Controls Ltd.

Brand name : Waterfront

Body marking :  (DN) GGG50 PN16

Model no. : WF661S

Origin : PRC

Sample submitted by : Gate Way Valve & Fitting Ltd.

Test standard : BS EN 12334 : 2001 / WIS 4-52-01 December 1992 : Issue 1 / BS EN 12266-1 : 2012 / BS EN ISO 6892-1 : 2009 /
BS EN 1563 : 2011 / BS EN 10088-1 : 2014 / BS EN 10088-3 : 2014

Test period : 29 April to 08 May 2020

A) Sample List

DN (mm)	Specimen no.
65	BC0200416-002-MISL
80	BC0200416-003-MISL
100	BC0200416-004-MISL
125	BC0200416-005-MISL
150	BC0200416-006-MISL
200	BC0200416-007-MISL
250	BC0200416-008-MISL
300	BC0200416-009-MISL

B) Test Item

1) Dimensions Check (BS EN 12334 : 2001 Clause 4.1.3)

DN (mm)	Test results	Castco LRN
65	Passed	BC0200416-001-MISL
80	Passed	
100	Passed	
125	Passed	
150	Passed	
200	Passed	
250	Passed	
300	Passed	

Remark(s) :

1. This page no. 1A of this summary supersedes page no. 1 of the previous summary of Reference no. : BC-SUMMARY-2020-52 issued on 14 May 2020.

Summary of Test Results

Reference no. : BC-SUMMARY-2020-52

B) Test Item (cont')

2) Coating Thickness Test (WIS 4-52-01 December 1992 : Issue 1 Clause 12.7.1 & Appendix B)

DN (mm)	Test results	Castco LRN
65	Passed	BC0200416-001-MISL
80	Passed	
100	Passed	
125	Passed	
150	Passed	
200	Passed	
250	Passed	
300	Passed	

3) Pressure Test (BS EN 12334 : 2001 Clause 5.1 / BS EN 12266-1 : 2012 Annex A)

DN (mm)	Test results	Castco LRN
65	Passed	BC0200416-001-MISL
80	Passed	
100	Passed	
125	Passed	
150	Passed	
200	Passed	
250	Passed	
300	Passed	

4) Tensile Test (BS EN 1563 : 2011 Clause 7.2.1.1 Table 1 (Grade EN-GJS-500-7) and Clause 9.1 / BS EN ISO 6892-1 : 2009)

DN (mm)	Test results	Castco LRN
65	Passed	BC0200416-001-MISL
100	Passed	
150	Passed	
200	Passed	
300	Passed	

5) Chemical Composition - Disc (BS EN 10088-1 : 2014 Table 2 Grade 1.4401 (316))

DN (mm)	Test results	Castco LRN
65	Passed	MS0200424-1
100	Passed	MS0200424-4
150	Passed	MS0200424-7
200	Passed	MS0200424-10
300	Passed	MS0200424-13

Remark(s) :

1. This page no. 2A of this summary supersedes page no. 2 of the previous summary of Reference no. : BC-SUMMARY-2020-52 issued on 14 May 2020.

Summary of Test Results

Reference no. : BC-SUMMARY-2020-52

B) Test Item (con't)

6) Chemical Composition - Shaft (BS EN 10088-3 : 2014 Table 2 Grade 1.4401 (316))

DN (mm)	Test results	Castco LRN
65	Passed	MS0200424-2
100	Passed	MS0200424-5
150	Passed	MS0200424-8
200	Passed	MS0200424-11
300	Passed	MS0200424-14

Remark(s) :

1. This page no. 3A of this summary supersedes page no. 3 of the previous summary of Reference no. : BC-SUMMARY-2020-52 issued on 14 May 2020.

Prepare by :  **FU HO MAN**
Assistant Technical Manager
Date : 03 August 2020

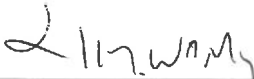
Review by :  **WONG KA MAN**
Senior Manager
Date : 03 August 2020

Test Report

Check Valves - Dimensions Check
(BS EN 12334 : 2001 Clause 4.1.3)

Date of issue : 03 August 2020

Page 1A of 10 page(s)

Castco LRN : BC0200416-001-MISL

Details as supplied by customer

Customer : Gate Way Valve & Fitting Ltd.

Customer's ref. no. : - -

Address : Flat A1, 4/F Galaxy Factory Building, 25 Luk Hop Street, San Po Kong, Kowloon

Contract no. : - -

Job title : - -

Sample description : Wafer Check Valve

Nominal pressure (PN) : 16

Manufacturer : Waterfront Fluid Controls Ltd.

Brand name : Waterfront

Body marking : (DN) GGG50 PN16

Model no. : WF661S

Origin : PRC

Sample submitted by : Gate Way Valve & Fitting Ltd.

Laboratory test results

Date of sample received : 16 April 2020

Date of test : 04 May 2020

Specimen no.		BC0200416-002-MISL	BC0200416-003-MISL	BC0200416-004-MISL	BC0200416-005-MISL	BC0200416-006-MISL	BC0200416-007-MISL	BC0200416-008-MISL	BC0200416-009-MISL
DN (mm)		65	80	100	125	150	200	250	300
Face-to-face (mm)	Measured mean value	46	64	64	70	76	89	114	114
	BS EN 558 : 2008 requirement	44 to 48	62 to 66	62 to 66	68 to 72	74 to 78	87 to 91	112 to 116	112 to 116
ØA (mm)	Measured mean value	127	142	163	193	218	274	328	382
	Manufacturer requirement	127	142	162	192	217	272	328	383
ØB (mm)	Measured mean value	80	94	118	145	170	223	265	310
	Manufacturer requirement	80	94	117	145	170	224	265	310

Remark(s) :

1. Test results relate only to the specimen tested.
2. Test results of sample comply with the requirement of BS EN 12334 : 2001 Clause 4.1.3 (effect of measurement uncertainty has not been taken into account).
3. Test results of sample comply with the requirement of BS EN 558 : 2008 Table 2 (Series 16) (effect of measurement uncertainty has not been taken into account).
4. This page no. 1A of this test report supersedes page no. 1 of the previous test report of Castco LRN : BC0200416-001-MISL issued on 14 May 2020 with amendment : "Waterfront Fluid Control Ltd." in "Manufacturer" was corrected as "Waterfront Fluid Controls Ltd." due to customer request.

Checked by : **FU HO MAN**
Assistant Technical Manager

Certified by : **WONG KA MAN**
Senior Manager

香港粉嶺安居街33號
香港粉嶺安全街29A號
E-mail: info@castco.com.hk

33, On Kui Street, Fanling, Hong Kong. Tel: 2597 8333
29A, On Chuen Street, Fanling, Hong Kong. Fax: 2597 8399
Website: www.castco.com.hk

Test Report

Valves - Coating Thickness Measurement

(Water Industry Specification 4-52-01 Dec. 1992 : Issue 1 Appendix B in conjunction with the following specification(s):
Water Industry Specification 4-52-01 Dec. 1992 : Issue 1 Clause 12.7.1)

Date of issue : 03 August 2020

Page 2A of 10 page(s)

Castco LRN : BC0200416-001-MISL

Details as supplied by customer

Customer : Gate Way Valve & Fitting Ltd.

Customer's ref. no. : - -

Address : Flat A1, 4/F Galaxy Factory Building, 25 Luk Hop Street, San Po Kong, Kowloon

Contract no. : - -

Job title : - -

Sample description : Wafer Check Valve

Nominal pressure (PN) : 16

Manufacturer : Waterfront Fluid Controls Ltd.

Brand name : Waterfront

Body marking :  (DN) GGG50 PN16

Model no. : WF661S

Origin : PRC

Sample submitted by : Gate Way Valve & Fitting Ltd.

Laboratory test results

Date of sample received : 16 April 2020

Date of test : 04 May 2020

Specimen no.	BC0200416-002-MISL	BC0200416-003-MISL	BC0200416-004-MISL	BC0200416-005-MISL	BC0200416-006-MISL	BC0200416-007-MISL	BC0200416-008-MISL	BC0200416-009-MISL	
DN (mm)	65	80	100	125	150	200	250	300	
Ambient temperature (°C)	24.0	24.0	24.0	24.0	24.0	24.0	24.0	24.0	
Measured value of coating thickness at external surface (µm)	1	373	276	253	437	278	505	265	486
	2	344	290	405	349	264	273	454	290
	3	300	331	416	320	310	393	413	374
	4	254	316	282	275	407	486	344	484
	5	308	277	275	316	490	435	329	275
Measured value of coating thickness at internal surface (µm)	6	426	414	401	341	463	258	486	468
	7	250	440	344	251	313	276	434	334
	8	268	515	283	308	260	443	326	451
	9	364	330	321	291	271	335	278	403
	10	330	291	324	264	324	378	489	543
	11	265	263	295	365	422	252	283	395
	12	316	254	263	479	457	286	381	510
	13	288	280	259	431	399	290	298	547
	14	253	296	389	307	442	263	354	577
	15	267	407	257	272	478	400	291	583
Mean	307.1	332.0	317.8	333.7	371.9	351.5	361.7	448.0	
Minimum coating thickness (µm)	250	254	253	251	260	252	265	275	
Maximum coating thickness (µm)	426	515	416	479	490	505	489	583	
Standard deviation (µm)	52.1	76.6	59.3	68.2	85.7	88.0	76.9	99.6	
Manufacturer requirement (µm)	Minimum coating thickness	N/A	N/A	N/A	N/A	N/A	N/A	N/A	N/A
	Maximum coating thickness	N/A	N/A	N/A	N/A	N/A	N/A	N/A	N/A

Remark(s) :

- Test results relate only to the specimen tested.
- This page no. 2A of this test report supersedes page no. 2 of the previous test report of Castco LRN : BC0200416-001-MISL issued on 14 May 2020 with amendment : "Waterfront Fluid Control Ltd." in "Manufacturer" was corrected as "Waterfront Fluid Controls Ltd." due to customer request.

Checked by :

 **FU HO MAN**
Assistant Technical Manager

Approved Signatory :

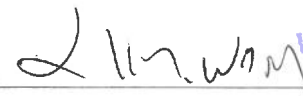
 **WONG KA MAN**
Senior Manager

Form no. : BC_VALVES_CT_WIS 4-52-01_T_dd_22/04/2020

香港粉嶺安居街33號
香港粉嶺安全街29A號
E-mail: info@castco.com.hk

33, On Kui Street, Fanling, Hong Kong. Tel: 2597 8333
29A, On Chuen Street, Fanling, Hong Kong. Fax: 2597 8399
Website: www.castco.com.hk

Test Report

Metallic Valves - Shell and Seat Tightness
(BS EN 12266-1 : 2012 Annex A3 and A4)

Date of issue : 03 August 2020

Page 3A of 10 page(s)

Castco LRN : BC0200416-001-MISL

Details as supplied by customer

Customer : Gate Way Valve & Fitting Ltd.

Customer's ref. no. : - -

Address : Flat A1, 4/F Galaxy Factory Building, 25 Luk Hop Street, San Po Kong, Kowloon

Contract no. : - -

Job title : - -

Sample description : Wafer Check Valve

Nominal pressure (PN) : 16

Manufacturer : Waterfront Fluid Controls Ltd.

Brand name : Waterfront

Body marking :  (DN) GGG50 PN16

Model no. : WF661S

Origin : PRC

Sample submitted by : Gate Way Valve & Fitting Ltd.

Laboratory test results

Date of sample received : 16 April 2020

Date of test : 08 to 09 May 2020

A) Shell Tightness

Specimen no.	BC0200416-002-MISL	BC0200416-003-MISL	BC0200416-004-MISL	BC0200416-005-MISL	BC0200416-006-MISL	BC0200416-007-MISL	BC0200416-008-MISL	BC0200416-009-MISL
DN (mm)	65	80	100	125	150	200	250	300
Water temperature (°C)	24.0	24.0	24.0	24.0	24.0	24.0	24.0	24.0
Apply pressure (bar)	24	24	24	24	24	24	24	24
Test duration (s)	60	60	60	60	60	120	120	120
Visually detectable leakage	No	No	No	No	No	No	No	No
Requirement	Visually detectable leakage is not permitted							

Remark(s) :

1. This page no. 3A of this test report supersedes page no. 3 of the previous test report of Castco LRN : BC0200416-001-MISL issued on 14 May 2020 with amendment : "Waterfront Fluid Control Ltd." in "Manufacturer" was corrected as "Waterfront Fluid Controls Ltd." due to customer request.

Test Report

Metallic Valves - Shell and Seat Tightness
(BS EN 12266-1 : 2012 Annex A3 and A4)

Date of issue : 03 August 2020

Page 4A of 10 page(s)

Castco LRN : BC0200416-001-MISL

Laboratory test results (con't)

Page 2 of 2 page(s)

Specimen no.	BC0200416-002-MISL	BC0200416-003-MISL	BC0200416-004-MISL	BC0200416-005-MISL	BC0200416-006-MISL	BC0200416-007-MISL	BC0200416-008-MISL	BC0200416-009-MISL
DN (mm)	65	80	100	125	150	200	250	300
Water temperature (°C)	24.0	24.0	24.0	24.0	24.0	24.0	24.0	24.0
Apply pressure (bar)	17.6	17.6	17.6	17.6	17.6	17.6	17.6	17.6
Test duration (s)	60	60	60	60	60	120	120	120
Leakage rate (mm ³ /s)	0	0	0	0	0	0	0	0
Requirement	The leakage rate shall not exceed specified in BS EN 12266-1 : 2012 Annex A.4.3 Table A.5							

Remark(s) :

1. Test results relate only to the specimen tested.
2. Test results of sample comply with the requirement of BS EN 12334 : 2001 Clause 5.1 (effect of measurement uncertainty has not been taken into account).
3. This page no. 4A of this test report supersedes page no. 4 of the previous test report of Castco LRN : BC0200416-001-MISL issued on 14 May 2020 with amendment : "Waterfront Fluid Control Ltd." in "Manufacturer" in Page 3 was corrected as "Waterfront Fluid Controls Ltd." due to customer request.

Checked by : _____

FU HO MAN
Assistant Technical Manager

Approved Signatory : _____

WONG KA MAN
Senior Manager

Test Report
Metallic Materials - Tensile Test of Metallic Materials
(BS EN ISO 6892-1 : 2009)

Date of issue : 03 August 2020

Page 5A of 10 page(s)

Castco LRN : BC0200416-001-MISL

Details as supplied by customer

Customer : Gate Way Valve & Fitting Ltd.

Customer's ref. no. : - -

Address : Flat A1, 4/F Galaxy Factory Building, 25 Luk Hop Street, San Po Kong, Kowloon

Contract no. : - -

Job title : - -

Sample description : Wafer Check Valve

Nominal pressure (PN) : 16

Manufacturer : Waterfront Fluid Controls Ltd.

Brand name : Waterfront

Body marking :  (DN) GGG50 PN16

Model no. : WF661S

Origin : PRC

Sample submitted by : Gate Way Valve & Fitting Ltd.

Acceptance standard : BS EN 1563 : 2011 Clause 7.2.1.1 Table 1 (Grade EN-GJS-500-7) and Clause 9.1

Laboratory Test Result

Date of sample received : 16 April 2020

Date of test : 09 May 2020

Tensile Test

Specimen no.	DN (mm)	Type & Prepar'n	Specimen length (mm)	Area (mm ²)	Yield strength (MPa)	Tensile strength (MPa)	Elongation (%)	Position of Fracture	Remark
BC0200416-002-MISL	65	A, M	157	152.0	384	592	9.5	--	--
BC0200416-004-MISL	100	A, M	162	158.8	363	566	11.3	--	--
BC0200416-006-MISL	150	A, M	159	152.0	391	544	8.8	--	--
BC0200416-007-MISL	200	A, M	157	153.7	370	558	9.4	--	--
BC0200416-009-MISL	300	A, M	156	153.7	391	569	10.5	--	--

Remarks :

- Legends : A - Proportional ; B - Non - proportional ; M - Machined ; N - Unmachined ;
+ This measurement is 'invalid' which relates to the position of fracture only.
- The yield stress is determined at 0.2% proof strength.
- Test results relate only to the specimen tested.
- Test results comply with BS EN 1563 : 2011 Table 1 (effect of measurement uncertainty has not been taken into account).
- The requirement of BS EN 1563 : 2011 Table 1 : 0.2% proof strength = min. 320 MPa; Tensile strength = min. 500 MPa; Elongation = min. 7%.
- This page no. 5A of this test report supersedes page no. 5 of the previous test report of Castco LRN : BC0200416-001-MISL issued on 14 May 2020 with amendment : "Waterfront Fluid Control Ltd." in "Manufacturer" was corrected as "Waterfront Fluid Controls Ltd." and "Remark 5" was added due to customer request.

Checked by :



FU HO MAN
Assistant Technical Manager

Approved Signatory :

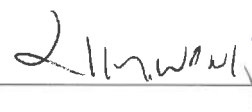

WONG KA MAN
Senior Manager

Form No. ST 6892_T1(for BC)_dd_02/01/2020

Test Report

Check Valves - Dimensions Check
(BS EN 12334 : 2001 Clause 4.1.3)

Date of issue : 14 May 2020

Page 6 of 10 page(s)

Castco LRN : BC0200416-001-MISL

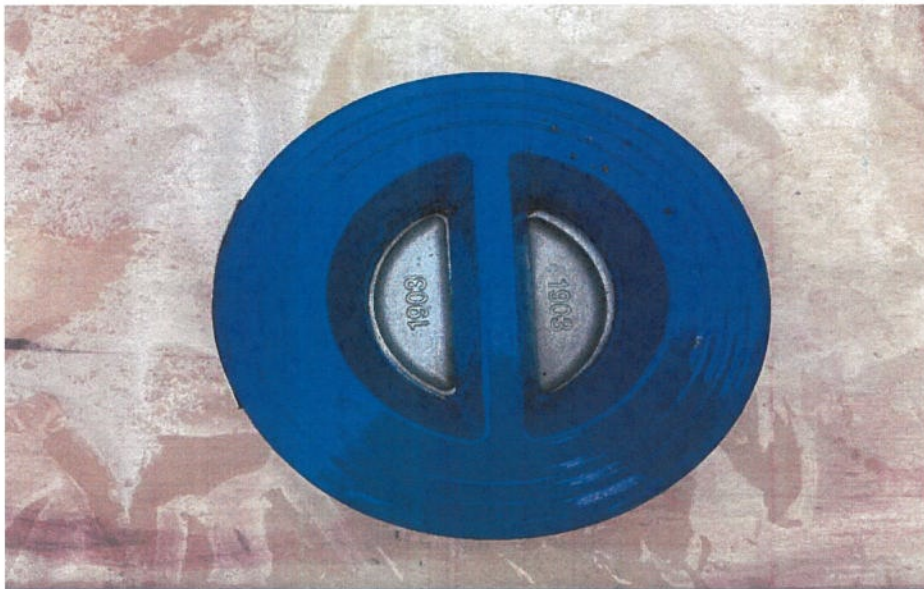
Appendix ABC0200416-002-MISLBC0200416-003-MISL

Appendix BBC0200416-004-MISLBC0200416-005-MISL

Test Report

Check Valves - Dimensions Check
(BS EN 12334 : 2001 Clause 4.1.3)

Date of issue : 14 May 2020

Page 8 of 10 page(s)

Castco LRN : BC0200416-001-MISL

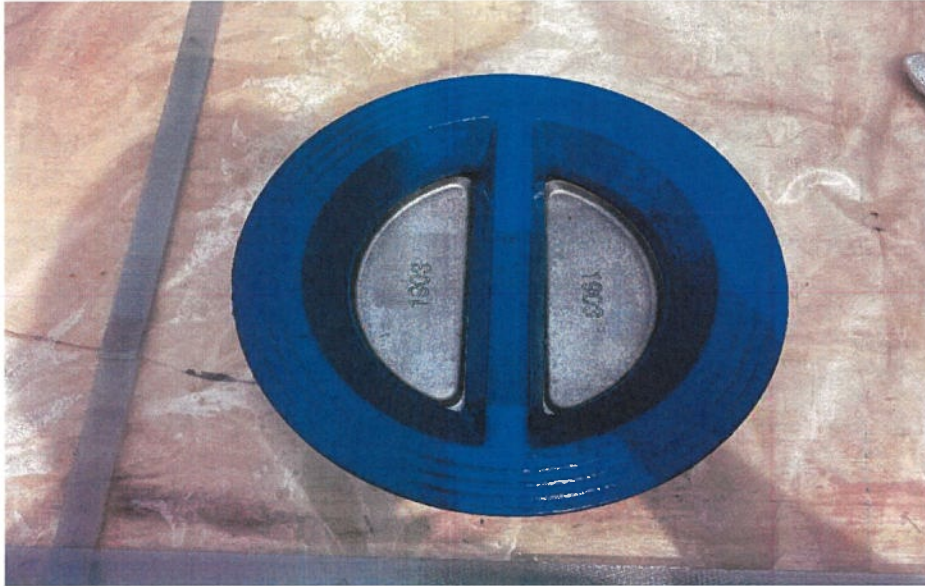
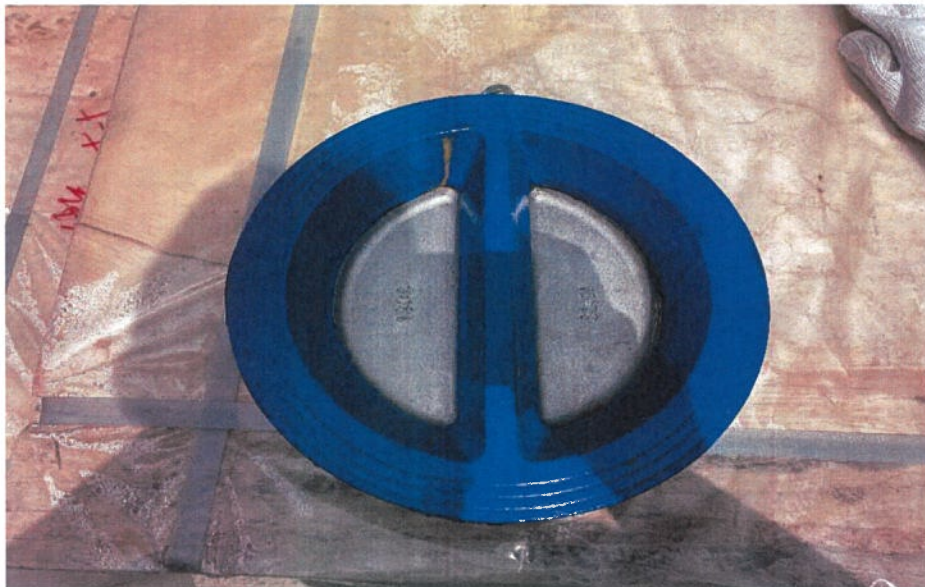
Appendix CBC0200416-006-MISLBC0200416-007-MISL

Test Report

Check Valves - Dimensions Check
(BS EN 12334 : 2001 Clause 4.1.3)

Date of issue : 14 May 2020

Page 9 of 10 page(s)

Castco LRN : BC0200416-001-MISL

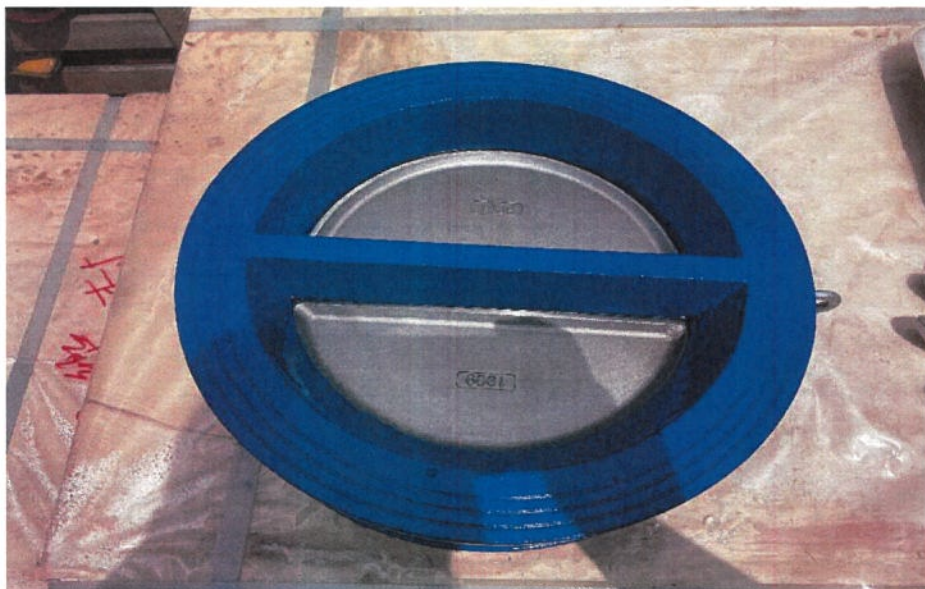
Appendix DBC0200416-008-MISLBC0200416-009-MISL

Test Report

Check Valves - Dimensions Check
(BS EN 12334 : 2001 Clause 4.1.3)

Date of issue : 14 May 2020

Page 10 of 10 page(s)

Castco LRN : BC0200416-001-MISL

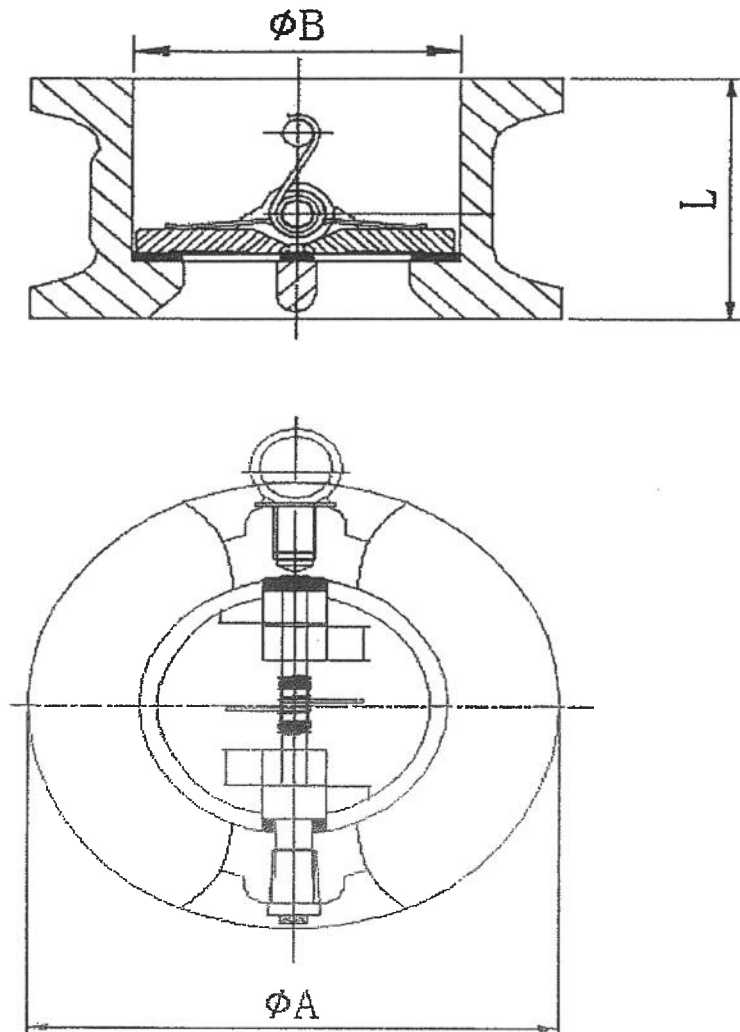
Appendix EDimensions Figure

End of Report

Form no. : BC_CHECK VALVE_DIM_BSEN12334_2001_T_dd_30/10/2019

**Test Report
Chemical Analysis of Steel**

Date of issue: 04-08-2020

Page 1A of 2

Castco LRN: MS0200424-1

Details as supplied by customer

Name of Customer : Gate Way Valve & Fitting Limited
Address : Flat A1, 4/F, 25 Luk Hop Street, San Po Kong, Kowloon
Job Title : --
Contract No. : --
Customer's Ref. No. : --

Sample details as supplied by customer

Date Sampled : --
Date of Sample Received : 24-04-2020
Test Period : 29-04-2020 to 08-05-2020
Sample Description : DN65 Wafer Check Valve (Disc)
Specification : BS EN 10088-1:2014, Table 2, Grade 1.4401 (316)
Location of Work : -- / Brand Name: Waterfront
Specimen No. : BC0200416-002-MISL
Sample Identification No. : -- / Model No.: WF661S
Manufacturer : Waterfront Fluid Controls Ltd. / Origin: PRC

Test Method(s):-

- 1) BS EN ISO 15350 : 2010
- 2) ST-Multi-1(ICP-OES)
- 3) BS EN ISO 15351: 2010

Remark(s):

- I. Test results only relate to the specimen tested.
- II. This page no. 1A of this test report supersedes page no. 1 of the previous test report of Castco LRN MS0200424-1 issued on 12-05-2020.
- III. Refer to the previous test report of Castco LRN MS0200424-1, the sample details were revised in this issue due to the supplementary information of the client.

Checked by :

Lau Hiu Yat

Assistant Technical Manager

Approved Signatory :

Cheng Chi Fai

Senior Manager

Test Report**Chemical Analysis of Steel**

Date of issue: 12-05-2020

Page 2 of 2

Castco LRN: MS0200424-1

Chemical Analysis		Result
1) Total Carbon Content	C %	0.025
1) Total Sulfur Content	S %	0.0047
2) Chromium	Cr %	16.83
2) Manganese	Mn %	0.978
2) Molybdenum	Mo %	2.21
2) Nickel	Ni %	10.43
2) Phosphorus	P %	0.038
2) Silicon	Si %	0.365
3) Nitrogen	N %	0.043

End of Report

Form No.: CHM Steel-1 T dd 16/12/2015

Appendix A

Summary of Chemical Analysis of Steel

Date of issue: 04-08-2020

Page 1A of 1

Castco LRN: MS0200424-1

Name of Customer: Gate Way Valve & Fitting Limited

Job Title: --

Contract No.: --

Customer's Ref. No.: --

Date of Received by Lab.: 24-04-2020

Testing Period: 29-04-2020 to 08-05-2020

Castco LRN:	MS0200424-1			
Sample I.D. No.:	-- / Model No.: WF661S			
Specimen No.:	BC0200416-002-MISL			
Sample Description :	DN65 Wafer Check Valve (Disc)			
Location of Work:	-- / Brand Name: Waterfront			
Manufacturer:	Waterfront Fluid Controls Ltd. / Origin: PRC			
Specification: BS EN 10088-1:2014, Table 2, Grade 1.4401 (316)	Test Results		Within / Exceed limit	
Carbon C	0.07 max.	%	0.025	Within limit
Sulfur S	0.015 max.	%	0.0047	Within limit
Chromium Cr	16.5 to 18.5	%	16.83	Within limit
Manganese Mn	2.00 max.	%	0.978	Within limit
Molybdenum Mo	2.00 to 2.50	%	2.21	Within limit
Nickel Ni	10.0 to 13.0	%	10.43	Within limit
Phosphorus P	0.045 max.	%	0.038	Within limit
Silicon Si	1.00 max.	%	0.365	Within limit
Nitrogen N	0.10 max.	%	0.043	Within limit

Remark(s):

- I. Test results only relate to the specimen tested.
- II. Test results of the specimen are in compliance with the chemical requirements of BS EN 10088-1:2014, Table 2, Grade 1.4401 (316).
- III. This page no. 1A of this Appendix A supersedes page no. 1 of the previous Appendix A of Castco LRN MS0200424-1 issued on 12-05-2020.
- IV. Refer to the previous Appendix A of Castco LRN MS0200424-1, the sample details were revised in this issue due to the supplementary information of the client.

**Test Report
Chemical Analysis of Steel**

Date of issue: 10-06-2020

Page 1 of 2

Castco LRN: MS0200528-2

Details as supplied by customer

Name of Customer : Gate Way Valve & Fitting Limited
Address : Flat A1, 4/F, 25 Luk Hop Street, San Po Kong, Kowloon
Job Title : Testing of water check value for application of GA
Contract No. : --
Customer's Ref. No. : --

Sample details as supplied by customer

Date Sampled : --
Date of Sample Received : 28-05-2020
Test Period : 04-06-2020 to 09-06-2020
Sample Description : DN65 Wafer Valve (Shaft)
Specification : BS EN 10088-3:2014, Table 2, Grade 1.4301 (304)
Location of Work : --
Manufacturer : Waterfront Fluid Control Ltd.
Specimen No. : BC0200416-002-MISL
Sample Identification No. : -- / Model No. : WF661S
Origin : PRC

Test Method(s):-

- 1) BS EN ISO 15350 : 2010
- 2) ST-Multi-1(ICP-OES)
- 3) BS EN ISO 15351: 2010

Remark:

- I. Test results only relate to the specimen tested.

Checked by :

Lau Hui Yat
Assistant Technical Manager

Approved Signatory :

Cheng Chi Fai
Senior Manager

Test Report
Chemical Analysis of Steel

Date of issue: 10-06-2020

Page 2 of 2

Castco LRN: MS0200528-2

Chemical Analysis		Result
1) Total Carbon Content	C %	0.032
1) Total Sulfur Content	S %	0.0047
2) Chromium	Cr %	18.00
2) Manganese	Mn %	1.13
2) Nickel	Ni %	8.02
2) Phosphorus	P %	0.039
2) Silicon	Si %	0.461
3) Nitrogen	N %	0.097

End of Report

Form No.: CHM Steel-1 T dd 16/12/2015

Appendix A

Summary of Chemical Analysis of Steel

Date of issue: 10-06-2020

Page 1 of 1

Castco LRN: MS0200528-2

Name of Customer: Gate Way Valve & Fitting Limited

Job Title: Testing of water check value for application of GA

Contract No.: --

Customer's Ref. No.: --

Date of Received by Lab.: 28-05-2020

Testing Period: 04-06-2020 to 09-06-2020

Castco LRN:	MS0200528-2				
Sample I.D. No.:	-- / Model No. : WF661S				
Sample Description :	DN65 Wafer Valve (Shaft)				
Location of Work:	--				
Manufacturer :	Waterfront Fluid Control Ltd.				
Specimen No. :	BC0200416-002-MISL				
Brand Name:	Waterfront				
Origin:	PRC				
Specification: BS EN 10088-3:2014, Table 2, Grade 1.4301 (304)			Test Results	Within / Exceed limit	
Carbon	C	0.07 max.	%	0.032	Within limit
Sulfur	S	0.030 max.	%	0.0047	Within limit
Chromium	Cr	17.5 to 19.5	%	18.00	Within limit
Manganese	Mn	2.00 max.	%	1.13	Within limit
Nickel	Ni	8.0 to 10.5	%	8.02	Within limit
Phosphorus	P	0.045 max.	%	0.039	Within limit
Silicon	Si	1.00 max.	%	0.461	Within limit
Nitrogen	N	0.10 max.	%	0.097	Within limit

Remark(s):

I. Test results only relate to the specimen tested.

II. Test results of the specimen are in compliance with the chemical requirements of BS EN 10088-3:2014, Table 2, Grade 1.4301 (304).

**Test Report
Chemical Analysis of Steel**

Date of issue: 04-08-2020

Page 1A of 2

Castco LRN: MS0200424-4

Details as supplied by customer

Name of Customer : Gate Way Valve & Fitting Limited
Address : Flat A1, 4/F, 25 Luk Hop Street, San Po Kong, Kowloon
Job Title : --
Contract No. : --
Customer's Ref. No. : --

Sample details as supplied by customer

Date Sampled : --
Date of Sample Received : 24-04-2020
Test Period : 29-04-2020 to 08-05-2020
Sample Description : DN100 Wafer Check Valve (Disc)
Specification : BS EN 10088-1:2014, Table 2, Grade 1.4401 (316)
Location of Work : -- / Brand Name: Waterfront
Specimen No. : BC0200416-004-MISL
Sample Identification No. : -- / Model No.: WF661S
Manufacturer : Waterfront Fluid Controls Ltd. / Origin: PRC

Test Method(s):-

- 1) BS EN ISO 15350 : 2010
- 2) ST-Multi-1(ICP-OES)
- 3) BS EN ISO 15351: 2010

Remark(s):

- I. Test results only relate to the specimen tested.
- II. This page no. 1A of this test report supersedes page no. 1 of the previous test report of Castco LRN MS0200424-4 issued on 12-05-2020.
- III. Refer to the previous test report of Castco LRN MS0200424-4, the sample details were revised in this issue due to the supplementary information of the client.

Checked by :

Lau Hiu Yat
Assistant Technical Manager

Approved Signatory :

Cheng Chi Fai
Senior Manager

Test Report**Chemical Analysis of Steel**

Date of issue: 12-05-2020

Page 2 of 2

Castco LRN: MS0200424-4

Chemical Analysis		Result
¹⁾ Total Carbon Content	C %	0.025
¹⁾ Total Sulfur Content	S %	0.0049
²⁾ Chromium	Cr %	16.56
²⁾ Manganese	Mn %	0.963
²⁾ Molybdenum	Mo %	2.04
²⁾ Nickel	Ni %	10.10
²⁾ Phosphorus	P %	0.037
²⁾ Silicon	Si %	0.359
³⁾ Nitrogen	N %	0.043

End of Report

Form No.: CHM Steel-1 T dd 16/12/2015

Appendix A

Summary of Chemical Analysis of Steel

Date of issue: 04-08-2020

Page 1A of 1

Castco LRN: MS0200424-4

Name of Customer: Gate Way Valve & Fitting Limited

Job Title: --

Contract No.: --

Customer's Ref. No.: --

Date of Received by Lab.: 24-04-2020

Testing Period: 29-04-2020 to 08-05-2020

Castco LRN:	MS0200424-4				
Sample I.D. No.:	-- / Model No.: WF661S				
Specimen No.:	BC0200416-004-MISL				
Sample Description :	DN100 Wafer Check Valve (Disc)				
Location of Work:	-- / Brand Name: Waterfront				
Manufacturer:	Waterfront Fluid Controls Ltd. / Origin: PRC				
Specification: BS EN 10088-1:2014, Table 2, Grade 1.4401 (316)			Test Results	Within / Exceed limit	
Carbon	C	0.07 max.	%	0.025	Within limit
Sulfur	S	0.015 max.	%	0.0049	Within limit
Chromium	Cr	16.5 to 18.5	%	16.56	Within limit
Manganese	Mn	2.00 max.	%	0.963	Within limit
Molybdenum	Mo	2.00 to 2.50	%	2.04	Within limit
Nickel	Ni	10.0 to 13.0	%	10.10	Within limit
Phosphorus	P	0.045 max.	%	0.037	Within limit
Silicon	Si	1.00 max.	%	0.359	Within limit
Nitrogen	N	0.10 max.	%	0.043	Within limit

Remark(s):

- I. Test results only relate to the specimen tested.
- II. Test results of the specimen are in compliance with the chemical requirements of BS EN 10088-1:2014, Table 2, Grade 1.4401 (316).
- III. This page no. 1A of this Appendix A supersedes page no. 1 of the previous Appendix A of Castco LRN MS0200424-4 issued on 12-05-2020.
- IV. Refer to the previous Appendix A of Castco LRN MS0200424-4, the sample details were revised in this issue due to the supplementary information of the client.

**Test Report
Chemical Analysis of Steel**

Date of issue: 10-06-2020

Page 1 of 2

Castco LRN: MS0200528-3

Details as supplied by customer

Name of Customer : Gate Way Valve & Fitting Limited
Address : Flat A1, 4/F, 25 Luk Hop Street, San Po Kong, Kowloon
Job Title : Testing of water check value for application of GA
Contract No. : --
Customer's Ref. No. : --

Sample details as supplied by customer

Date Sampled : --
Date of Sample Received : 28-05-2020
Test Period : 04-06-2020 to 09-06-2020
Sample Description : DN100 Wafer Valve (Shaft)
Specification : BS EN 10088-3:2014, Table 2, Grade 1.4301 (304)
Location of Work : --
Manufacturer : Waterfront Fluid Control Ltd.
Specimen No. : BC0200416-004-MISL
Sample Identification No. : -- / Model No. : WF661S
Origin : PRC

Test Method(s):-

- 1) BS EN ISO 15350 : 2010
- 2) ST-Multi-1(ICP-OES)
- 3) BS EN ISO 15351: 2010

Remark:

- I. Test results only relate to the specimen tested.

Checked by :

Lau Hiu Yat
Assistant Technical Manager

Approved Signatory :

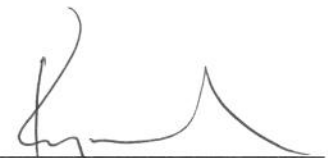
Cheng Chi Fai
Senior Manager

**Test Report
Chemical Analysis of Steel**

Date of issue: 10-06-2020

Page 2 of 2

Castco LRN: MS0200528-3

Chemical Analysis		Result
1) Total Carbon Content	C %	0.032
1) Total Sulfur Content	S %	0.0046
2) Chromium	Cr %	17.83
2) Manganese	Mn %	1.13
2) Nickel	Ni %	8.02
2) Phosphorus	P %	0.039
2) Silicon	Si %	0.464
3) Nitrogen	N %	0.097

End of Report

Form No.: CHM Steel-I T dd 16/12/2015

Appendix A
Summary of Chemical Analysis of Steel

Date of issue: 10-06-2020

Page 1 of 1

Castco LRN: MS0200528-3

Name of Customer: Gate Way Valve & Fitting Limited
 Job Title: Testing of water check value for application of GA
 Contract No.: --
 Customer's Ref. No.: --
 Date of Received by Lab.: 28-05-2020 Testing Period: 04-06-2020 to 09-06-2020

Castco LRN:	MS0200528-3				
Sample I.D. No.:	-- / Model No. : WF661S				
Sample Description :	DN100 Wafer Valve (Shaft)				
Location of Work:	--				
Manufacturer :	Waterfront Fluid Control Ltd.				
Specimen No. :	BC0200416-004-MISL				
Brand Name:	Waterfront				
Origin:	PRC				
Specification: BS EN 10088-3:2014, Table 2, Grade 1.4301 (304)			Test Results	Within / Exceed limit	
Carbon	C	0.07 max.	%	0.032	Within limit
Sulfur	S	0.030 max.	%	0.0046	Within limit
Chromium	Cr	17.5 to 19.5	%	17.83	Within limit
Manganese	Mn	2.00 max.	%	1.13	Within limit
Nickel	Ni	8.0 to 10.5	%	8.02	Within limit
Phosphorus	P	0.045 max.	%	0.039	Within limit
Silicon	Si	1.00 max.	%	0.464	Within limit
Nitrogen	N	0.10 max.	%	0.097	Within limit

Remark(s):

- I. Test results only relate to the specimen tested.
- II. Test results of the specimen are in compliance with the chemical requirements of BS EN 10088-3:2014, Table 2, Grade 1.4301 (304).

Test Report

Chemical Analysis of Steel

Date of issue: 04-08-2020

Page 1A of 2

Castco LRN: MS0200424-7

Details as supplied by customer

Name of Customer : Gate Way Valve & Fitting Limited

Address : Flat A1, 4/F, 25 Luk Hop Street, San Po Kong, Kowloon

Job Title : --

Contract No. : --

Customer's Ref. No. : --

Sample details as supplied by customer

Date Sampled : --

Date of Sample Received : 24-04-2020

Test Period : 29-04-2020 to 08-05-2020

Sample Description : DN150 Wafer Check Valve (Disc)

Specification : BS EN 10088-1:2014, Table 2, Grade 1.4401 (316)

Location of Work : -- / Brand Name: Waterfront

Specimen No. : BC0200416-006-MISL

Sample Identification No. : -- / Model No.: WF661S

Manufacturer : Waterfront Fluid Controls Ltd. / Origin: PRC

Test Method(s):-

- 1) BS EN ISO 15350 : 2010
- 2) ST-Multi-1(ICP-OES)
- 3) BS EN ISO 15351: 2010

Remark(s):

- I. Test results only relate to the specimen tested.
- II. This page no. 1A of this test report supersedes page no. 1 of the previous test report of Castco LRN MS0200424-7 issued on 12-05-2020.
- III. Refer to the previous test report of Castco LRN MS0200424-7, the sample details were revised in this issue due to the supplementary information of the client.

Checked by :

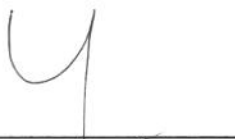
 Lau Hiu Yat
 Assistant Technical Manager

Approved Signatory :

 Cheng Chi Fai
 Senior Manager

Test Report**Chemical Analysis of Steel**

Date of issue: 12-05-2020

Page 2 of 2

Castco LRN: MS0200424-7

Chemical Analysis		Result
1) Total Carbon Content	C %	0.024
1) Total Sulfur Content	S %	0.0048
2) Chromium	Cr %	16.51
2) Manganese	Mn %	0.970
2) Molybdenum	Mo %	2.08
2) Nickel	Ni %	10.13
2) Phosphorus	P %	0.038
2) Silicon	Si %	0.363
3) Nitrogen	N %	0.045

End of Report

Form No.: CHM Steel-1 T dd 16/12/2015

Appendix A

Summary of Chemical Analysis of Steel

Date of issue: 04-08-2020

Page 1A of 1

Castco LRN: MS0200424-7

Name of Customer: Gate Way Valve & Fitting Limited

Job Title: --

Contract No.: --

Customer's Ref. No.: --

Date of Received by Lab.: 24-04-2020

Testing Period: 29-04-2020 to 08-05-2020

Castco LRN:	MS0200424-7				
Sample I.D. No.:	-- / Model No.: WF661S				
Specimen No.:	BC0200416-006-MISL				
Sample Description :	DN150 Wafer Check Valve (Disc)				
Location of Work:	-- / Brand Name: Waterfront				
Manufacturer:	Waterfront Fluid Controls Ltd. / Origin: PRC				
Specification: BS EN 10088-1:2014, Table 2, Grade 1.4401 (316)			Test Results	Within / Exceed limit	
Carbon	C	0.07 max.	%	0.024	Within limit
Sulfur	S	0.015 max.	%	0.0048	Within limit
Chromium	Cr	16.5 to 18.5	%	16.51	Within limit
Manganese	Mn	2.00 max.	%	0.970	Within limit
Molybdenum	Mo	2.00 to 2.50	%	2.08	Within limit
Nickel	Ni	10.0 to 13.0	%	10.13	Within limit
Phosphorus	P	0.045 max.	%	0.038	Within limit
Silicon	Si	1.00 max.	%	0.363	Within limit
Nitrogen	N	0.10 max.	%	0.045	Within limit

Remark(s):

- I. Test results only relate to the specimen tested.
- II. Test results of the specimen are in compliance with the chemical requirements of BS EN 10088-1:2014, Table 2, Grade 1.4401 (316).
- III. This page no. 1A of this Appendix A supersedes page no. 1 of the previous Appendix A of Castco LRN MS0200424-7 issued on 12-05-2020.
- IV. Refer to the previous Appendix A of Castco LRN MS0200424-7, the sample details were revised in this issue due to the supplementary information of the client.

**Test Report
Chemical Analysis of Steel**

Date of issue: 10-06-2020

Page 1 of 2

Castco LRN: MS0200528-4

Details as supplied by customer

Name of Customer : Gate Way Valve & Fitting Limited
Address : Flat A1, 4/F, 25 Luk Hop Street, San Po Kong, Kowloon
Job Title : Testing of water check value for application of GA
Contract No. : --
Customer's Ref. No. : --

Sample details as supplied by customer

Date Sampled : --
Date of Sample Received : 28-05-2020
Test Period : 04-06-2020 to 09-06-2020
Sample Description : DN150 Wafer Valve (Shaft)
Specification : BS EN 10088-3:2014, Table 2, Grade 1.4301 (304)
Location of Work : --
Manufacturer : Waterfront Fluid Control Ltd.
Specimen No. : BC0200416-006-MISL
Sample Identification No. : -- / Model No. : WF661S
Origin : PRC

Test Method(s):-

- 1) BS EN ISO 15350 : 2010
- 2) ST-Multi-1(ICP-OES)
- 3) BS EN ISO 15351: 2010

Remark:

- I. Test results only relate to the specimen tested.

Checked by :

Lau Hiu Yat
Assistant Technical Manager

Approved Signatory :

Cheng Chi Fai
Senior Manager

**Test Report
Chemical Analysis of Steel**

Date of issue: 10-06-2020

Page 2 of 2

Castco LRN: MS0200528-4

Chemical Analysis		Result
1) Total Carbon Content	C %	0.033
1) Total Sulfur Content	S %	0.0048
2) Chromium	Cr %	17.88
2) Manganese	Mn %	1.13
2) Nickel	Ni %	8.03
2) Phosphorus	P %	0.039
2) Silicon	Si %	0.463
3) Nitrogen	N %	0.095

End of Report

Form No.: CHM Steel-1 T dd 16/12/2015

Appendix A
Summary of Chemical Analysis of Steel

Date of issue: 10-06-2020

Page 1 of 1

Castco LRN: MS0200528-4

Name of Customer: Gate Way Valve & Fitting Limited

Job Title: Testing of water check value for application of GA

Contract No.: --

Customer's Ref. No.: --

Date of Received by Lab.: 28-05-2020

Testing Period: 04-06-2020 to 09-06-2020

Castco LRN:	MS0200528-4	
Sample I.D. No.:	-- / Model No. : WF661S	
Sample Description :	DN150 Wafer Valve (Shaft)	
Location of Work:	--	
Manufacturer :	Waterfront Fluid Control Ltd.	
Specimen No. :	BC0200416-006-MISL	
Brand Name:	Waterfront	
Origin:	PRC	
Specification: BS EN 10088-3:2014, Table 2, Grade 1.4301 (304)	Test Results	Within / Exceed limit
Carbon C 0.07 max. %	0.033	Within limit
Sulfur S 0.030 max. %	0.0048	Within limit
Chromium Cr 17.5 to 19.5 %	17.88	Within limit
Manganese Mn 2.00 max. %	1.13	Within limit
Nickel Ni 8.0 to 10.5 %	8.03	Within limit
Phosphorus P 0.045 max. %	0.039	Within limit
Silicon Si 1.00 max. %	0.463	Within limit
Nitrogen N 0.10 max. %	0.095	Within limit

Remark(s):

I. Test results only relate to the specimen tested.

II. Test results of the specimen are in compliance with the chemical requirements of BS EN 10088-3:2014, Table 2, Grade 1.4301 (304).

Test Report

Chemical Analysis of Steel

Date of issue: 04-08-2020

Page 1A of 2

Castco LRN: MS0200424-10

Details as supplied by customer

Name of Customer : Gate Way Valve & Fitting Limited

Address : Flat A1, 4/F, 25 Luk Hop Street, San Po Kong, Kowloon

Job Title : --

Contract No. : --

Customer's Ref. No. : --

Sample details as supplied by customer

Date Sampled : --

Date of Sample Received : 24-04-2020

Test Period : 29-04-2020 to 08-05-2020

Sample Description : DN200 Wafer Check Valve (Disc)

Specification : BS EN 10088-1:2014, Table 2, Grade 1.4401 (316)

Location of Work : -- / Brand Name: Waterfront

Specimen No. : BC0200416-007-MISL

Sample Identification No. : -- / Model No.: WF661S

Manufacturer : Waterfront Fluid Controls Ltd. / Origin: PRC

Test Method(s):-

- 1) BS EN ISO 15350 : 2010
- 2) ST-Multi-1(ICP-OES)
- 3) BS EN ISO 15351: 2010

Remark(s):

- I. Test results only relate to the specimen tested.
- II. This page no. 1A of this test report supersedes page no. 1 of the previous test report of Castco LRN MS0200424-10 issued on 12-05-2020.
- III. Refer to the previous test report of Castco LRN MS0200424-10, the sample details were revised in this issue due to the supplementary information of the client.

Checked by :



Lau Hiu Yat
Assistant Technical Manager

Approved Signatory :



Cheng Chi Fai
Senior Manager

Test Report**Chemical Analysis of Steel**

Date of issue: 12-05-2020

Page 2 of 2

Castco LRN: MS0200424-10

Chemical Analysis		Result
¹⁾ Total Carbon Content	C %	0.027
¹⁾ Total Sulfur Content	S %	0.0052
²⁾ Chromium	Cr %	16.60
²⁾ Manganese	Mn %	0.968
²⁾ Molybdenum	Mo %	2.09
²⁾ Nickel	Ni %	10.15
²⁾ Phosphorus	P %	0.038
²⁾ Silicon	Si %	0.369
³⁾ Nitrogen	N %	0.042

End of Report

Form No.: CHM Steel-1 T dd 16/12/2015

Appendix A

Summary of Chemical Analysis of Steel

Date of issue: 04-08-2020

Page 1A of 1

Castco LRN: MS0200424-10

Name of Customer: Gate Way Valve & Fitting Limited

Job Title: --

Contract No.: --

Customer's Ref. No.: --

Date of Received by Lab.: 24-04-2020

Testing Period: 29-04-2020 to 08-05-2020

Castco LRN:	MS0200424-10				
Sample I.D. No.:	-- / Model No.: WF661S				
Specimen No.:	BC0200416-007-MISL				
Sample Description :	DN200 Wafer Check Valve (Disc)				
Location of Work:	-- / Brand Name: Waterfront				
Manufacturer:	Waterfront Fluid Controls Ltd. / Origin: PRC				
Specification: BS EN 10088-1:2014, Table 2, Grade 1.4401 (316)			Test Results	Within / Exceed limit	
Carbon	C	0.07 max.	%	0.027	Within limit
Sulfur	S	0.015 max.	%	0.0052	Within limit
Chromium	Cr	16.5 to 18.5	%	16.60	Within limit
Manganese	Mn	2.00 max.	%	0.968	Within limit
Molybdenum	Mo	2.00 to 2.50	%	2.09	Within limit
Nickel	Ni	10.0 to 13.0	%	10.15	Within limit
Phosphorus	P	0.045 max.	%	0.038	Within limit
Silicon	Si	1.00 max.	%	0.369	Within limit
Nitrogen	N	0.10 max.	%	0.042	Within limit

Remark(s):

- I. Test results only relate to the specimen tested.
- II. Test results of the specimen are in compliance with the chemical requirements of BS EN 10088-1:2014, Table 2, Grade 1.4401 (316).
- III. This page no. 1A of this Appendix A supersedes page no. 1 of the previous Appendix A of Castco LRN MS0200424-10 issued on 12-05-2020.
- IV. Refer to the previous Appendix A of Castco LRN MS0200424-10, the sample details were revised in this issue due to the supplementary information of the client.

**Test Report
Chemical Analysis of Steel**

Date of issue: 10-06-2020

Page 1 of 2

Castco LRN: MS0200528-5

Details as supplied by customer

Name of Customer : Gate Way Valve & Fitting Limited
Address : Flat A1, 4/F, 25 Luk Hop Street, San Po Kong, Kowloon
Job Title : Testing of water check value for application of GA
Contract No. : --
Customer's Ref. No. : --

Sample details as supplied by customer

Date Sampled : --
Date of Sample Received : 28-05-2020
Test Period : 04-06-2020 to 09-06-2020
Sample Description : DN200 Wafer Valve (Shaft)
Specification : BS EN 10088-3:2014, Table 2, Grade 1.4301 (304)
Location of Work : -
Manufacturer : Waterfront Fluid Control Ltd.
Specimen No. : BC0200416-007-MISL
Sample Identification No. : -- / Model No. : WF661S
Origin : PRC

Test Method(s):-

- 1) BS EN ISO 15350 : 2010
- 2) ST-Multi-1(ICP-OES)
- 3) BS EN ISO 15351: 2010

Remark:

- I. Test results only relate to the specimen tested.

Checked by :

Lau Hin Yat
Assistant Technical Manager

Approved Signatory :

Cheng Chi Fai
Senior Manager

Test Report
Chemical Analysis of Steel

Date of issue: 10-06-2020

Page 2 of 2

Castco LRN: MS0200528-5

Chemical Analysis		Result
1) Total Carbon Content	C %	0.032
1) Total Sulfur Content	S %	0.0049
2) Chromium	Cr %	18.04
2) Manganese	Mn %	1.14
2) Nickel	Ni %	8.11
2) Phosphorus	P %	0.040
2) Silicon	Si %	0.467
3) Nitrogen	N %	0.095

End of Report

Form No.: CHM Steel-1 T dd 16/12/2015

Appendix A
Summary of Chemical Analysis of Steel

Date of issue: 10-06-2020

Page 1 of 1

Castco LRN: MS0200528-5

Name of Customer: Gate Way Valve & Fitting Limited
Job Title: Testing of water check value for application of GA
Contract No.: --
Customer's Ref. No.: --
Date of Received by Lab.: 28-05-2020 Testing Period: 04-06-2020 to 09-06-2020

Castco LRN:	MS0200528-5				
Sample I.D. No.:	-- / Model No. : WF661S				
Sample Description :	DN200 Wafer Valve (Shaft)				
Location of Work:	-				
Manufacturer :	Waterfront Fluid Control Ltd.				
Specimen No. :	BC0200416-007-MISL				
Brand Name:	Waterfront				
Origin:	PRC				
Specification: BS EN 10088-3:2014, Table 2, Grade 1.4301 (304)			Test Results	Within / Exceed limit	
Carbon	C	0.07 max.	%	0.032	Within limit
Sulfur	S	0.030 max.	%	0.0049	Within limit
Chromium	Cr	17.5 to 19.5	%	18.04	Within limit
Manganese	Mn	2.00 max.	%	1.14	Within limit
Nickel	Ni	8.0 to 10.5	%	8.11	Within limit
Phosphorus	P	0.045 max.	%	0.040	Within limit
Silicon	Si	1.00 max.	%	0.467	Within limit
Nitrogen	N	0.10 max.	%	0.095	Within limit

Remark(s):

- I. Test results only relate to the specimen tested.
- II. Test results of the specimen are in compliance with the chemical requirements of BS EN 10088-3:2014, Table 2, Grade 1.4301 (304).

Test Report**Chemical Analysis of Steel**

Date of issue: 04-08-2020

Page 1A of 2

Castco LRN: MS0200424-13

Details as supplied by customer

Name of Customer : Gate Way Valve & Fitting Limited
 Address : Flat A1, 4/F, 25 Luk Hop Street, San Po Kong, Kowloon
 Job Title : --
 Contract No. : --
 Customer's Ref. No. : --

Sample details as supplied by customer

Date Sampled : --
 Date of Sample Received : 24-04-2020
 Test Period : 29-04-2020 to 08-05-2020
 Sample Description : DN300 Wafer Check Valve (Disc)
 Specification : BS EN 10088-1:2014, Table 2, Grade 1.4401 (316)
 Location of Work : -- / Brand Name: Waterfront
 Specimen No. : BC0200416-009-MISL
 Sample Identification No. : -- / Model No.: WF661S
 Manufacturer : Waterfront Fluid Controls Ltd. / Origin: PRC

Test Method(s):-

- 1) BS EN ISO 15350 : 2010
- 2) ST-Multi-1(ICP-OES)
- 3) BS EN ISO 15351: 2010

Remark(s):

- I. Test results only relate to the specimen tested.
- II. This page no. 1A of this test report supersedes page no. 1 of the previous test report of Castco LRN MS0200424-13 issued on 12-05-2020.
- III. Refer to the previous test report of Castco LRN MS0200424-13, the sample details were revised in this issue due to the supplementary information of the client.

Checked by :

 Lau Hiu Yat

Assistant Technical Manager

Approved Signatory :

 Cheng Chi Fai

Senior Manager

**Test Report
Chemical Analysis of Steel**

Date of issue: 12-05-2020

Page 2 of 2

Castco LRN: MS0200424-13

Chemical Analysis		Result
1) Total Carbon Content	C %	0.026
1) Total Sulfur Content	S %	0.0048
2) Chromium	Cr %	16.78
2) Manganese	Mn %	0.985
2) Molybdenum	Mo %	2.11
2) Nickel	Ni %	10.28
2) Phosphorus	P %	0.038
2) Silicon	Si %	0.370
3) Nitrogen	N %	0.044

End of Report

Form No.: CHM Steel-1 T dd 16/12/2015

Appendix A

Summary of Chemical Analysis of Steel

Date of issue: 04-08-2020

Page 1A of 1

Castco LRN: MS0200424-13

Name of Customer: Gate Way Valve & Fitting Limited

Job Title: --

Contract No.: --

Customer's Ref. No.: --

Date of Received by Lab.: 24-04-2020

Testing Period: 29-04-2020 to 08-05-2020

Castco LRN:	MS0200424-13				
Sample I.D. No.:	-- / Model No.: WF661S				
Specimen No.:	BC0200416-009-MISL				
Sample Description :	DN300 Wafer Check Valve (Disc)				
Location of Work:	-- / Brand Name: Waterfront				
Manufacturer:	Waterfront Fluid Controls Ltd. / Origin: PRC				
Specification: BS EN 10088-1:2014, Table 2, Grade 1.4401 (316)			Test Results	Within / Exceed limit	
Carbon	C	0.07 max.	%	0.026	Within limit
Sulfur	S	0.015 max.	%	0.0048	Within limit
Chromium	Cr	16.5 to 18.5	%	16.78	Within limit
Manganese	Mn	2.00 max.	%	0.985	Within limit
Molybdenum	Mo	2.00 to 2.50	%	2.11	Within limit
Nickel	Ni	10.0 to 13.0	%	10.28	Within limit
Phosphorus	P	0.045 max.	%	0.038	Within limit
Silicon	Si	1.00 max.	%	0.370	Within limit
Nitrogen	N	0.10 max.	%	0.044	Within limit

Remark(s):

- I. Test results only relate to the specimen tested.
- II. Test results of the specimen are in compliance with the chemical requirements of BS EN 10088-1:2014, Table 2, Grade 1.4401 (316).
- III. This page no. 1A of this Appendix A supersedes page no. 1 of the previous Appendix A of Castco LRN MS0200424-13 issued on 12-05-2020.
- IV. Refer to the previous Appendix A of Castco LRN MS0200424-13, the sample details were revised in this issue due to the supplementary information of the client.

Test Report
Chemical Analysis of SteelDate of issue: 10-06-2020
Page 1 of 2

Castco LRN: MS0200528-6

Details as supplied by customerName of Customer : Gate Way Valve & Fitting Limited
Address : Flat A1, 4/F, 25 Luk Hop Street, San Po Kong, Kowloon
Job Title : Testing of water check value for application of GA
Contract No. : --
Customer's Ref. No. : --**Sample details as supplied by customer**Date Sampled : --
Date of Sample Received : 28-05-2020
Test Period : 04-06-2020 to 09-06-2020
Sample Description : DN300 Wafer Valve (Shaft)
Specification : BS EN 10088-3:2014, Table 2, Grade 1.4301 (304)
Location of Work : --
Manufacturer : Waterfront Fluid Control Ltd.
Specimen No. : BC0200416-009-MISL
Sample Identification No. : -- / Model No. : WF661S
Origin : PRC**Test Method(s):-**

- 1) BS EN ISO 15350 : 2010
- 2) ST-Multi-1(ICP-OES)
- 3) BS EN ISO 15351: 2010

Remark:

I. Test results only relate to the specimen tested.

Checked by :

Lau Hin Yat
Assistant Technical Manager

Approved Signatory :

Cheng Chi Fai
Senior Manager

Test Report
Chemical Analysis of Steel

Date of issue: 10-06-2020

Page 2 of 2

Castco LRN: MS0200528-6

Chemical Analysis		Result
1) Total Carbon Content	C %	0.032
1) Total Sulfur Content	S %	0.0045
2) Chromium	Cr %	18.06
2) Manganese	Mn %	1.14
2) Nickel	Ni %	8.08
2) Phosphorus	P %	0.039
2) Silicon	Si %	0.467
3) Nitrogen	N %	0.090

End of Report

Form No.: CHM Steel-1 T dd 16/12/2015

Appendix A

Summary of Chemical Analysis of Steel

Date of issue: 10-06-2020

Page 1 of 1

Castco LRN: MS0200528-6

Name of Customer: Gate Way Valve & Fitting Limited

Job Title: Testing of water check value for application of GA

Contract No.: --

Customer's Ref. No.: --

Date of Received by Lab.: 28-05-2020

Testing Period: 04-06-2020 to 09-06-2020

Castco LRN:	MS0200528-6	
Sample I.D. No.:	-- / Model No. : WF661S	
Sample Description :	DN300 Wafer Valve (Shaft)	
Location of Work:	--	
Manufacturer :	Waterfront Fluid Control Ltd.	
Specimen No. :	BC0200416-009-MISL	
Brand Name:	Waterfront	
Origin:	PRC	
Specification: BS EN 10088-3:2014, Table 2, Grade 1.4301 (304)	Test Results	Within / Exceed limit
Carbon C 0.07 max. %	0.032	Within limit
Sulfur S 0.030 max. %	0.0045	Within limit
Chromium Cr 17.5 to 19.5 %	18.06	Within limit
Manganese Mn 2.00 max. %	1.14	Within limit
Nickel Ni 8.0 to 10.5 %	8.08	Within limit
Phosphorus P 0.045 max. %	0.039	Within limit
Silicon Si 1.00 max. %	0.467	Within limit
Nitrogen N 0.10 max. %	0.090	Within limit

Remark(s):

- I. Test results only relate to the specimen tested.
- II. Test results of the specimen are in compliance with the chemical requirements of BS EN 10088-3:2014, Table 2, Grade 1.4301 (304).